

PREPARATION OF THE M16A1 RIFLE

TEC LESSON NO. 551-101-8351-A

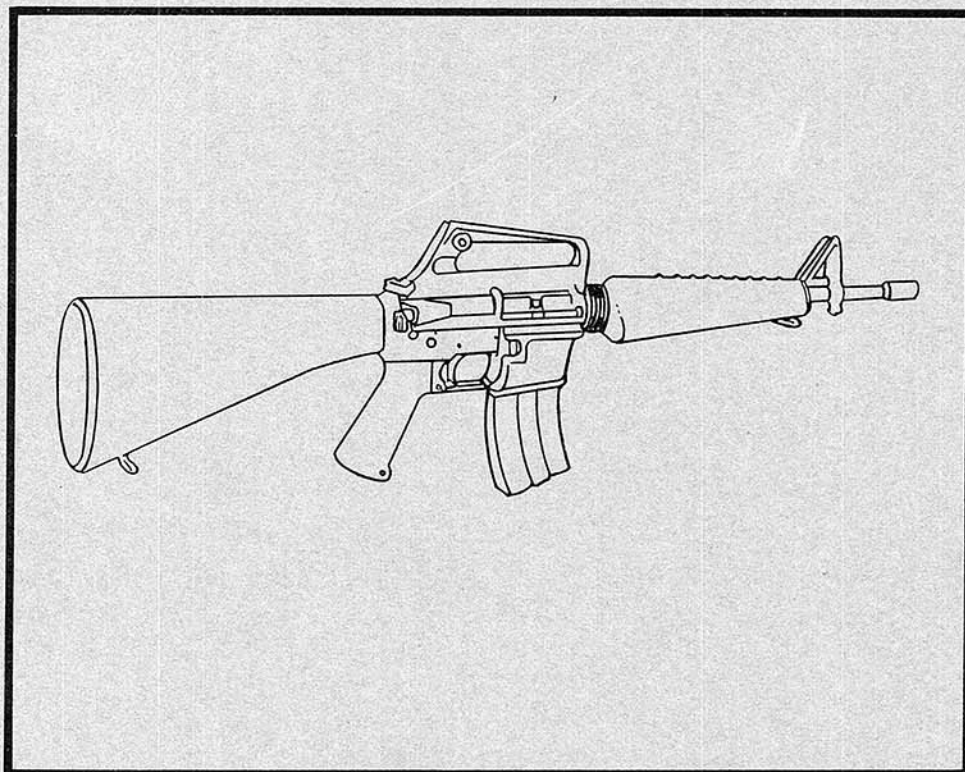

PRODUCED BY
US ARMY QUARTERMASTER
SCHOOL
FORT LEE, VIRGINIA



January 1982

Student/Supervisor Instructions and Pretest/Posttest are
contained within this
Lesson

Digitized by:

READ THE STUDENT/SUPERVISOR INSTRUCTIONS CAREFULLY.
BE SURE YOU UNDERSTAND THEM BEFORE CONTINUING THE LESSON.

When used in this publication, "he," "him," "his,"
and "men" represent both the masculine and feminine
genders unless otherwise stated.

STUDENT/SUPERVISOR INSTRUCTIONS

AUDIENCE

- MOS 76Y
- Skill levels 1 and 2

TRAINING OBJECTIVE

Given the equipment and materials required, the soldier will be able to:

- Clear the M16A1 rifle
- Perform a functional check on the M16A1 rifle

MATERIAL/EQUIPMENT/PERSONNEL REQUIRED TO COMPLETE THIS LESSON

- Pen or pencil
- Lesson booklet
- M16A1 rifle and magazine
- Punch, 1/16 pt. dia in., NSN 5120-00-240-6082

TIME REQUIRED

- Soldier must complete the task within 2 minutes

REFERENCES

- TM 9-1005-249-20

STUDENT INSTRUCTIONS

- Take the pretest. If you pass the pretest, you need not take this lesson.
- Insure that you have all material, equipment, or personnel required to complete this lesson.
- Read this lesson. Practice each step in the lesson until you can do it without looking at the book.
- Take the posttest. If you do not pass, read the lesson again and repeat the test.

- It is very important that you read every step in this lesson. Do not skip around and do the steps out of order. You could hurt yourself or harm the equipment. Do not do anything that is not explained in the lesson booklet, and observe all safety warnings. Safety warnings are printed in red. These are cautions or warnings you must observe so that you do not injure yourself or harm the equipment.
- Keep track of all dummy rounds. Keep them locked in your tool kit or some other location separate from live ammunition.
- Always clear any weapon before you work on it.
- Read all CAUTIONS printed in red BEFORE doing the next step.
- Be extra careful when working with springs that can fly out. Wear safety goggles.
- Do not write on this lesson booklet.

SUPERVISOR INSTRUCTIONS

- Insure that the student has completed the prerequisites listed above.
- Insure that the student has all material, equipment, or personnel required to complete this lesson.
- This lesson is self-teaching and self-paced. The soldier will learn the task by reading and doing the steps in the lesson. He can use as much time as needed, within reasonable limits, to learn the task.
- As a supervisor, you should be familiar with the lesson material so you can answer questions, score tests, and insure that all safety precautions and warnings are followed.
- Although this is a self-teaching program, it may be necessary for you to assist the soldier if he has difficulties. Everything the soldier needs to know to pass the test is in this booklet. When a soldier does not understand a step, it is usually because he is going too fast and skips a step. Reading the section again will often solve the problem. Occasionally, a soldier will not understand the whole lesson. If you are familiar with the weapon, you may explain the steps; or, if you will read the lesson yourself, you should be able to explain it to the soldier. If the weapon becomes jammed or is disassembled

beyond organizational level, and neither you nor the soldier can remedy the problem, take it to direct support maintenance for repair.

- Allow the student to read the lesson and practice the task before testing.
- Follow set-up and scoring instructions for the test.
- Do not aid the soldier in taking the test.
- Observe the soldier's performance in the pretest/posttest.
- Score each performance measure as GO/NO GO.
- Be sure the soldier completes the task within the required time limit.

PRETEST/POSTTEST

Type of Lesson: Quartermaster

TEC Lesson No.
551-101-8351-A

Preparation of the M16A1 Rifle

General Information

This pretest/posttest covers two basic actions: clearing the M16A1 rifle and performing a functional check on the M16A1 rifle. In order to pass the test, the soldier must receive a GO on all performance measures and must complete the task within 2 minutes. If he fails the test, the lesson must be repeated and the test retaken. The following items must be arranged on a table for the soldier's use during the test:

M16A1 Rifle and Magazine
Punch, 1/16 pt. dia in., NSN 5120-00-240-6082

The scorer must have a watch, a pen or pencil, paper, and the list of performance measures.

Test Instructions:

Clear and perform a function check on the M16A1 rifle on the table. All the tools you need are also on the table. You will have 2 minutes to complete the test.

NOTE TO SUPERVISOR/SCORER:

Please review the supervisor instructions at the beginning of the lesson and the information printed above. Be sure that all of the items listed above are available for use during the test. Read aloud the test instructions to the soldier, and begin timing his performance. Do not let the soldier continue past the time limit. On a separate sheet of paper, write GO or NO GO for each of the performance measures listed on the following page.

DO NOT WRITE ON THIS TEST.

Performance Measures:

GO

NO GO

- | | | |
|---|-------|-------|
| 1. The soldier clears the weapon. | | |
| a. The soldier makes sure the magazine has been removed. | _____ | _____ |
| b. The soldier makes sure there is no ammunition in the weapon. | _____ | _____ |
| c. The soldier puts the selector lever on "safe." | _____ | _____ |
| 2. The soldier checks the "safe" position. | | |
| a. The soldier puts the selector lever on "semi," pulls charging handle to the rear, then eases it forward. He puts the selector lever on "safe." | _____ | _____ |
| b. The soldier looks at hammer, then squeezes trigger. Hammer should not fall. | _____ | _____ |
| 3. The soldier checks the "semi" position. | | |
| a. The soldier puts the selector lever on "semi" and squeezes trigger. Hammer falls. | _____ | _____ |
| b. The soldier recocks hammer and releases trigger. Hammer falls halfway forward. | _____ | _____ |
| 4. The soldier checks the "auto" position. | | |
| a. The soldier puts the selector lever on "auto" and squeezes trigger. Hammer falls. | _____ | _____ |
| b. The soldier recocks hammer, releases trigger, and pushes forward on the automatic sear. Hammer falls. | _____ | _____ |
| c. The soldier recocks hammer, releases trigger and pushes forward on automatic sear. Hammer falls halfway forward. | _____ | _____ |
| 5. The soldier finishes the functional check. | | |
| a. The soldier puts the selector lever on "safe." | _____ | _____ |
| b. The soldier closes the receiver and pushes takedown pin all the way up. | _____ | _____ |
| c. The soldier puts selector lever on "semi." | _____ | _____ |
| d. The soldier clears the weapon. | _____ | _____ |
| 6. The soldier completes the test within 2 minutes. | _____ | _____ |

PREPARATION OF THE M16A1 RIFLE

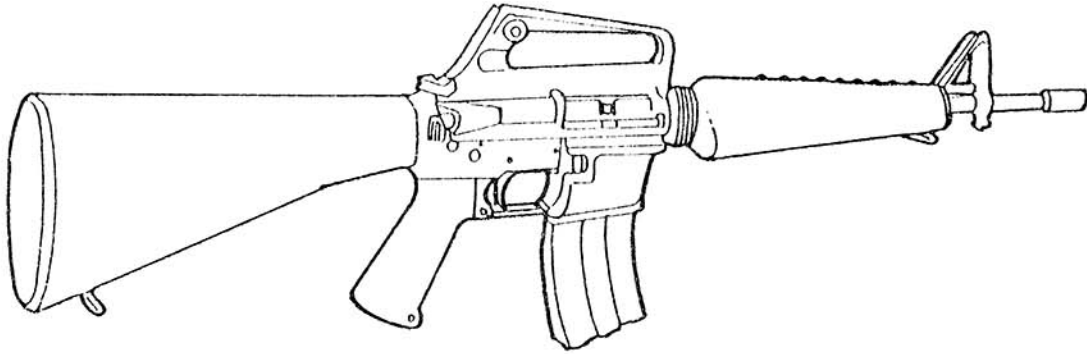

The M16A1 Rifle

INTRODUCTION:

This is TEC Lesson No. 551-101-8351-A, "Preparation of the M16A1 Rifle." This lesson will show you how to clear the rifle and how to perform a functional check on the rifle. By clearing the rifle, we mean making sure that the magazine has been removed and there is no ammunition in the weapon. Always remember to CLEAR THE RIFLE first. Whenever you pick up a rifle, CLEAR IT. When you are finished working with it, CLEAR IT.

EQUIPMENT/MATERIALS REQUIRED:

M16A1 rifle with magazine inserted
Punch, 1/16 pt. dia in., NSN 5120-00-240-6082

HOW TO CLEAR THE RIFLE

REMOVE THE MAGAZINE

STEP 1: Hold the rifle and press the magazine catch button. Pull the magazine down and away from the rifle.



Set the magazine aside.

INSPECT THE CHAMBER

STEP 1: Pull the charging handle to the rear and look directly into the chamber to be sure that it is clear of ammunition.

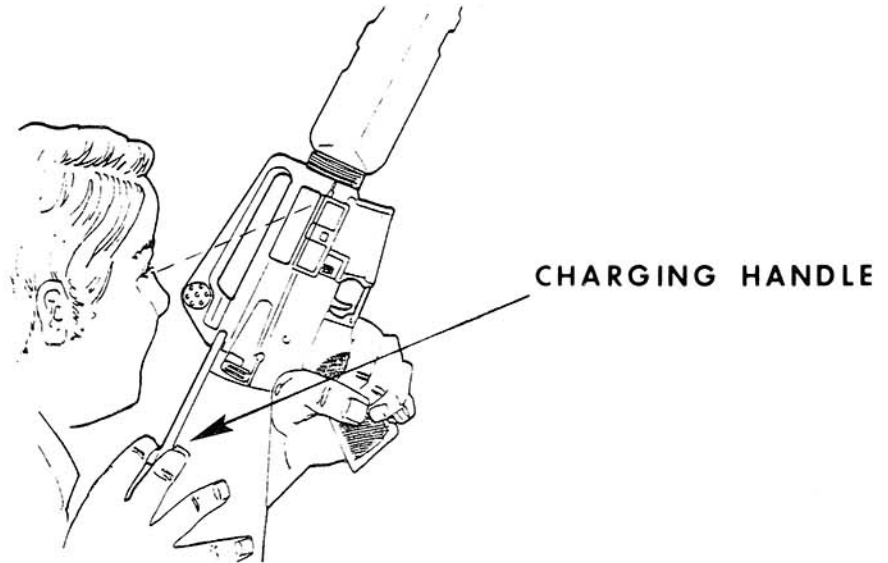

CAUTION:

IF YOU FIND A LIVE ROUND, TAKE IT OUT AND DISPOSE OF IT BY UNIT SOP.

STEP 2: Ease the charging handle forward and press the forward assist.

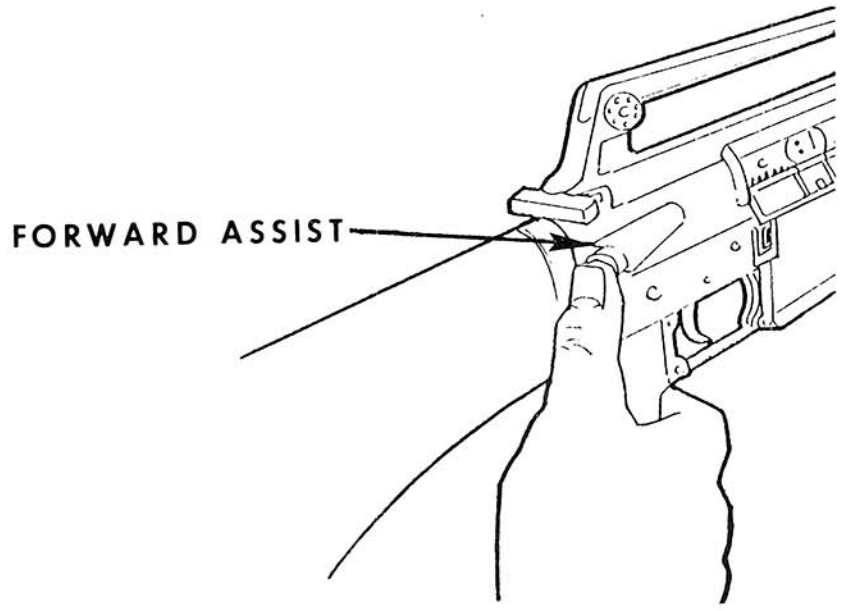

STEP 3: Put the selector lever on "SAFE" position.

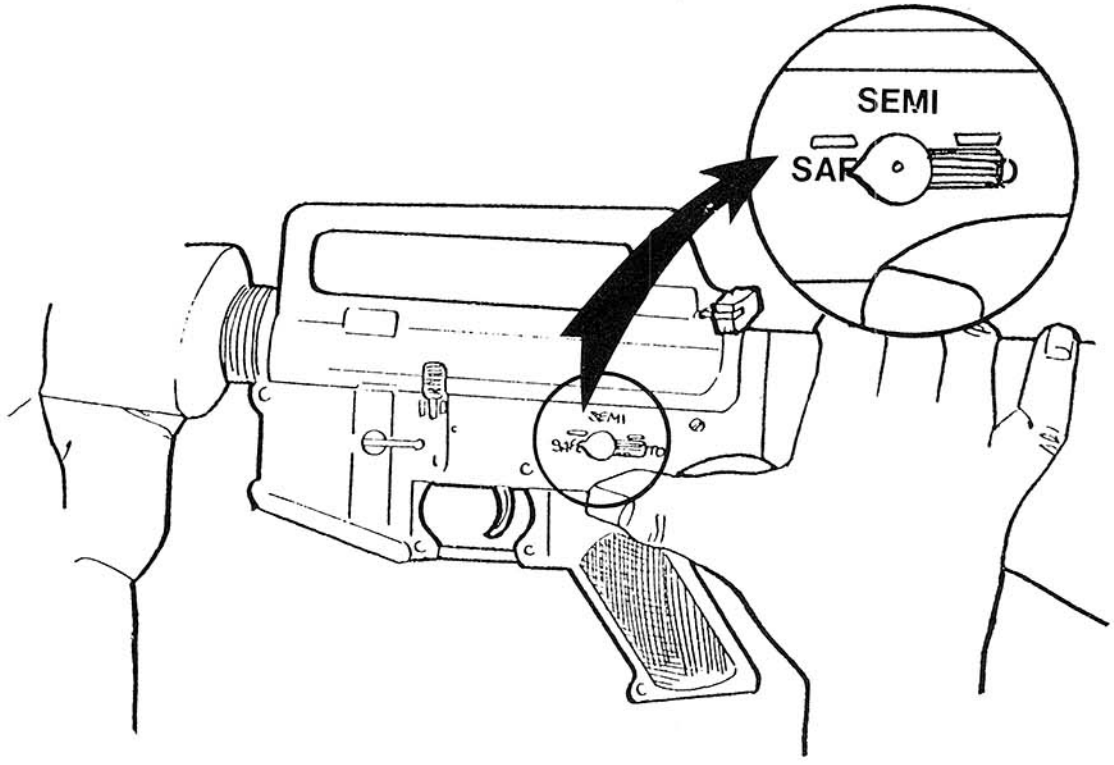

The weapon is now clear and safe to work on. You should be able to clear the weapon in less than 1 minute.

Practice the steps for clearing the rifle until you can clear it without help from the lesson.

Remember, you must always clear the rifle before you start to work on it or handle it for any reason.

The next part of this lesson will show you how to perform a functional check on the rifle.

Always perform this check after you assemble the rifle.

HOW TO DO A FUNCTIONAL CHECK ON THE M16A1 RIFLE

CHECK THE SAFE POSITION

STEP 1: Put the selector lever on SEMI.

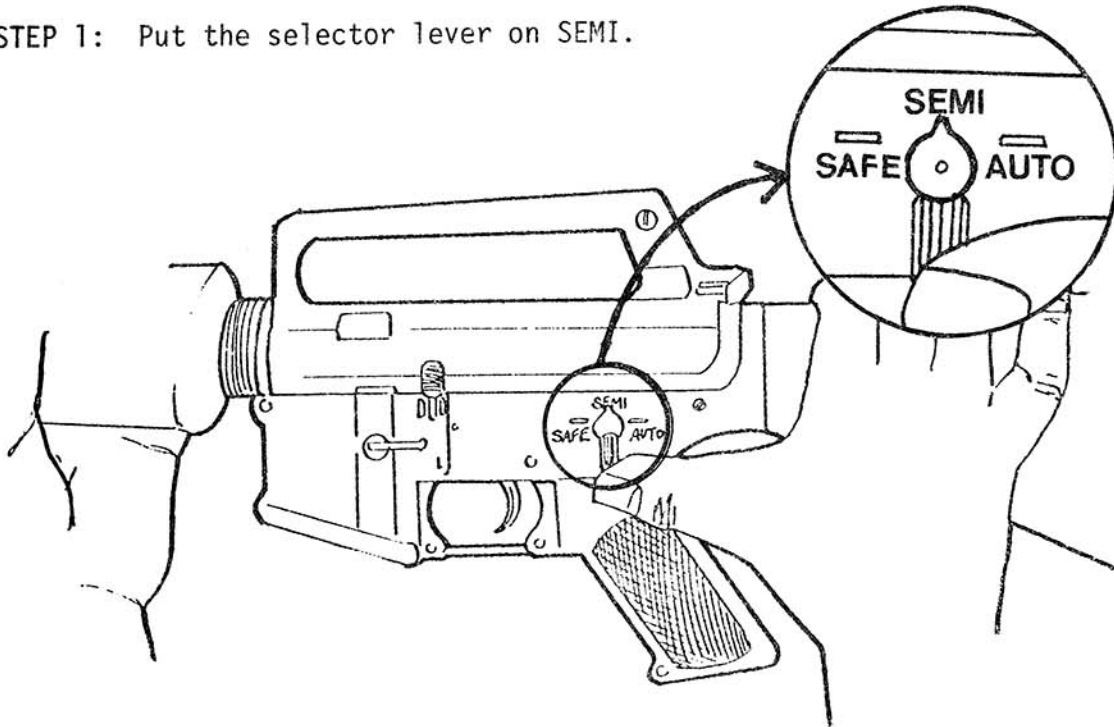

STEP 2: Pull the charging handle to the rear and ease it forward.
Put the selector lever on SAFE.

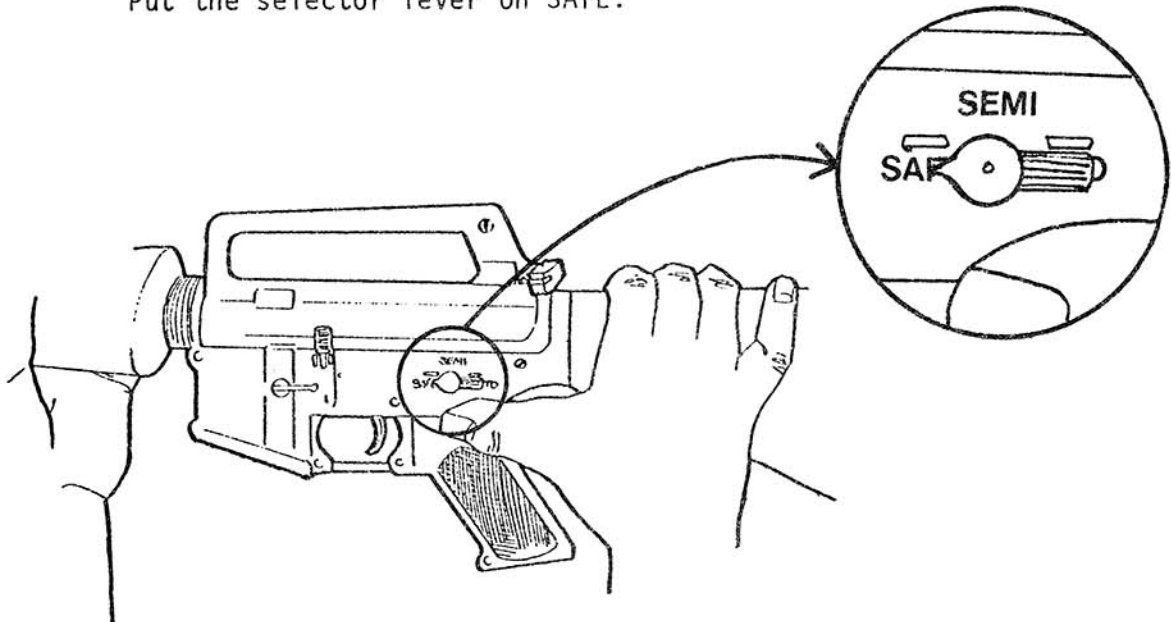

STEP 3: Push the takedown pin in with a punch as far as it will go and open the receivers.

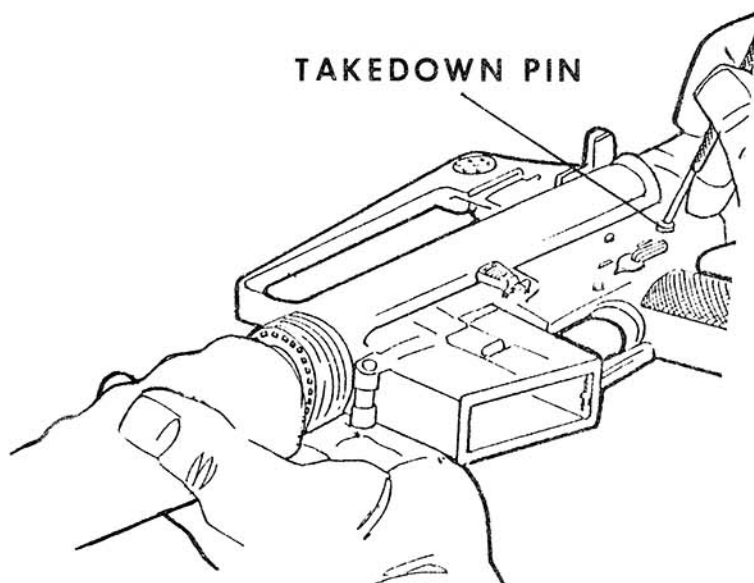

STEP 4: Look at the hammer.

It should be back in the cocked position.

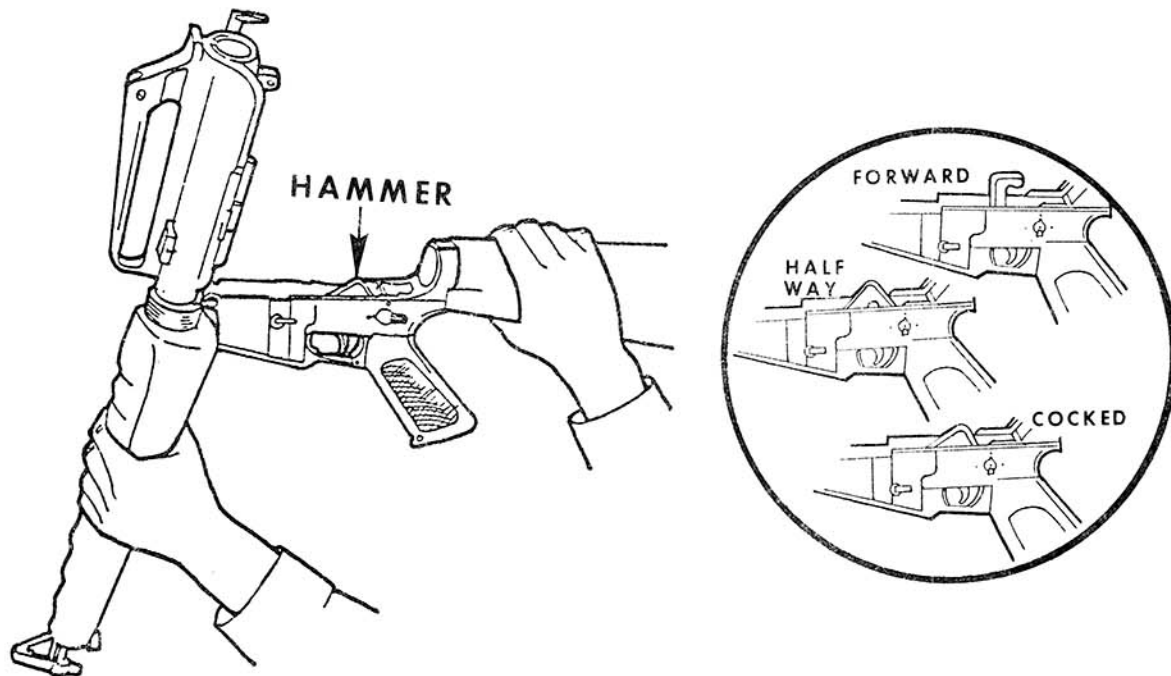

STEP 5: Squeeze the trigger.

The hammer should not fall.

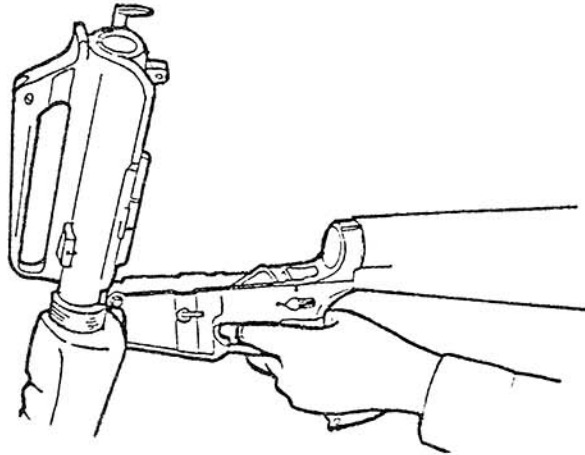

If the hammer falls, the selector lever or hammer is broken. Your troubleshooting lesson will show you how to correct this malfunction.

CHECK THE SEMI POSITION

STEP 1: Put the selector lever on SEMI.

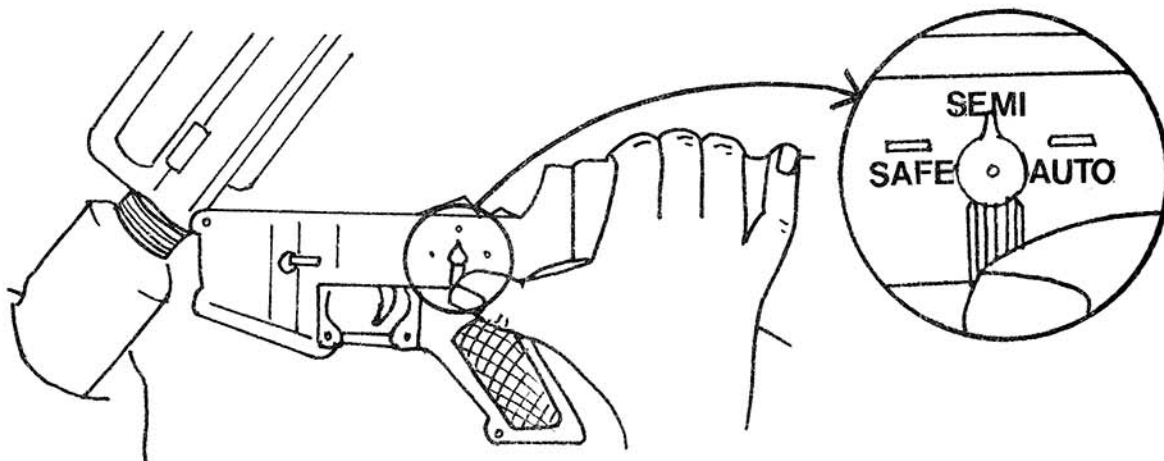

STEP 2: Squeeze the trigger.

The hammer should fall.

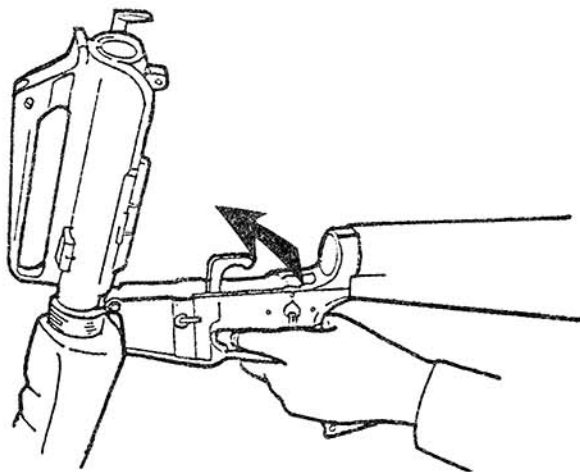

If hammer did not fall, your troubleshooting lesson will show you how to correct this malfunction.

STEP 3: Hold the trigger back and and recock the hammer by pushing it down with your thumb.

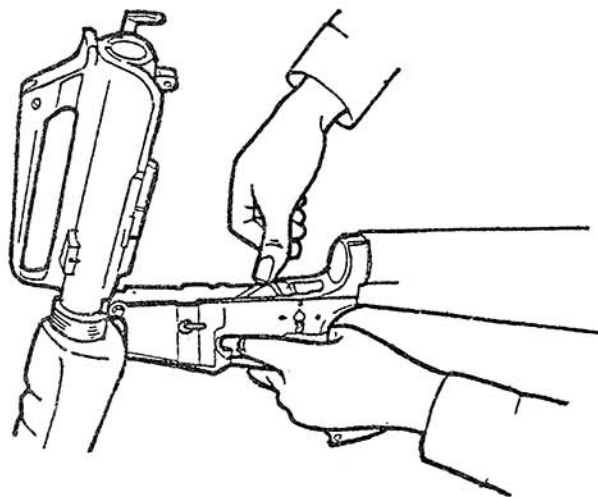

STEP 4: Release the trigger.
The hammer should fall halfway forward.

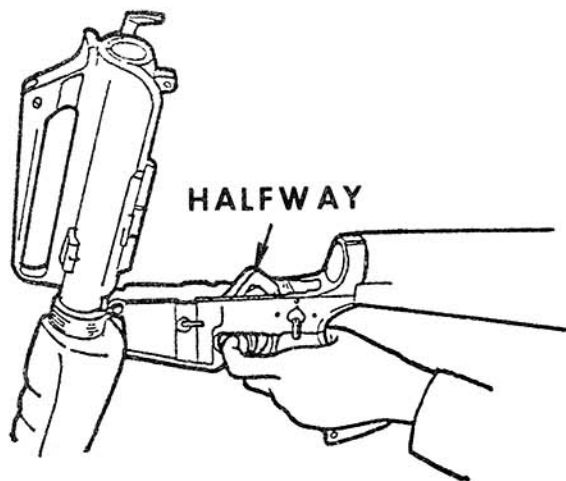

If the hammer did not fall halfway forward, your troubleshooting lesson will show you how to correct this malfunction.

CHECK THE AUTO POSITION

STEP 1: Put the selector lever on AUTO.

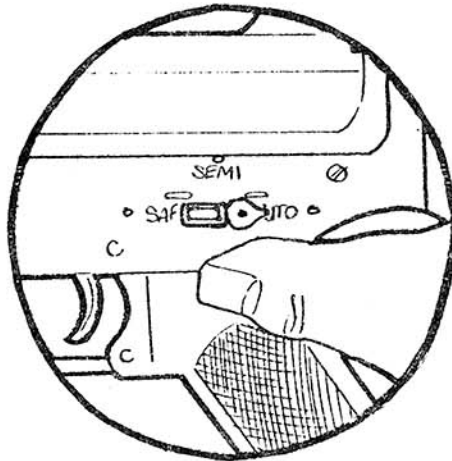

STEP 2: Squeeze the trigger.

The hammer should fall.

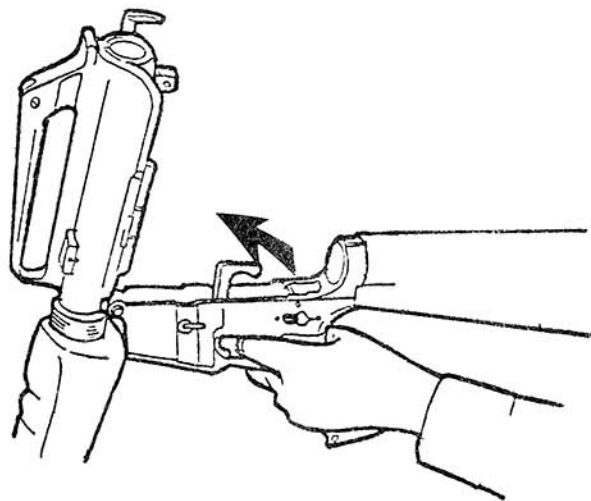

If the hammer did not fall, your troubleshooting lesson will show you how to correct this malfunction.

STEP 3: Hold the trigger back and recock the hammer.

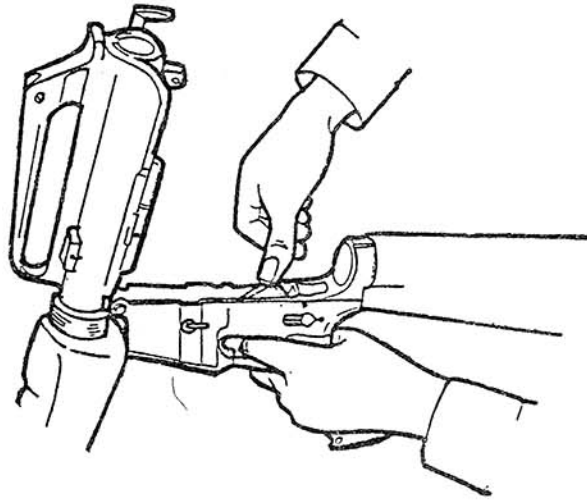

STEP 4: While holding the trigger, push forward on the automatic sear. The hammer should fall.

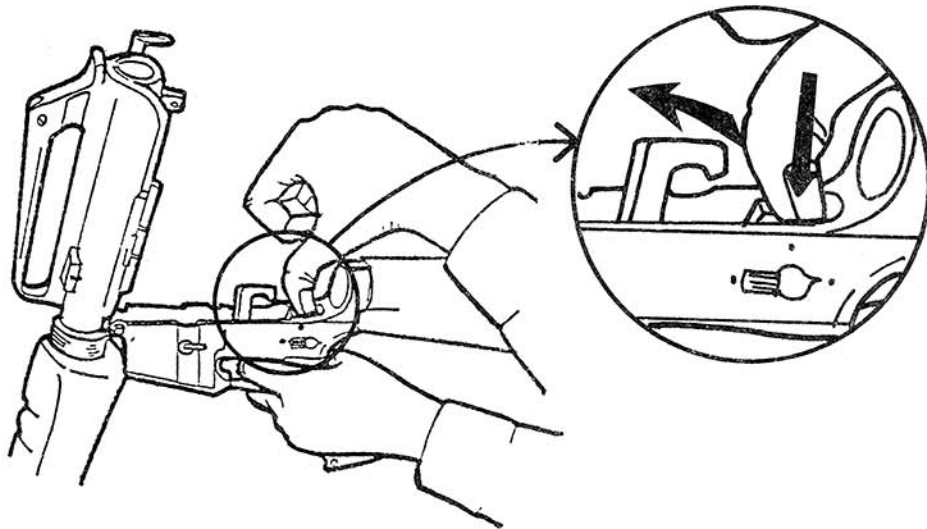

If the hammer did not fall, your troubleshooting lesson will show you how to correct this malfunction.

STEP 5: Hold the trigger back and recock the hammer.

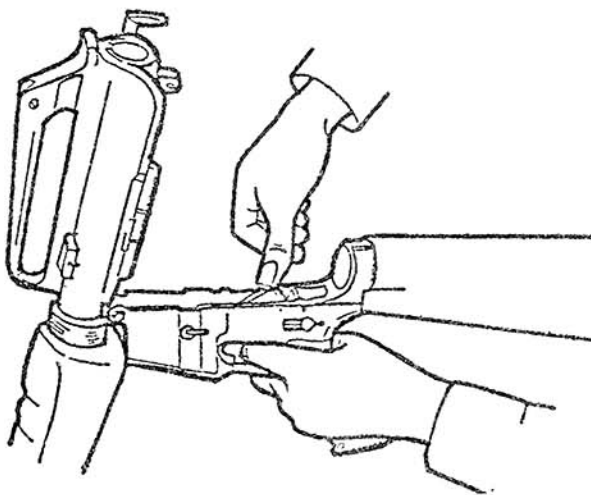

STEP 6: Release trigger and push forward on automatic sear.
Hammer should fall halfway forward.

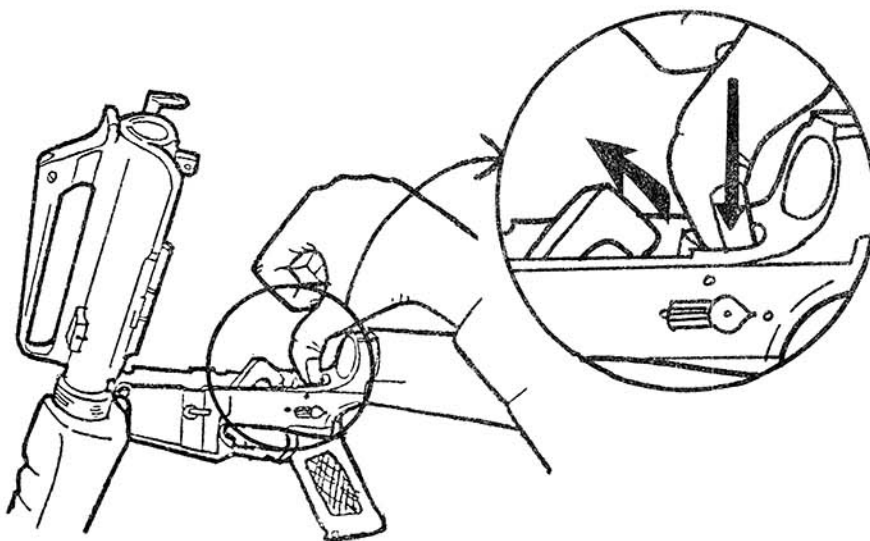

If hammer did not fall halfway forward, your troubleshooting lesson will show you how to correct this malfunction.

FINISH THE FUNCTIONAL CHECK

STEP 1: Put selector lever on SAFE.

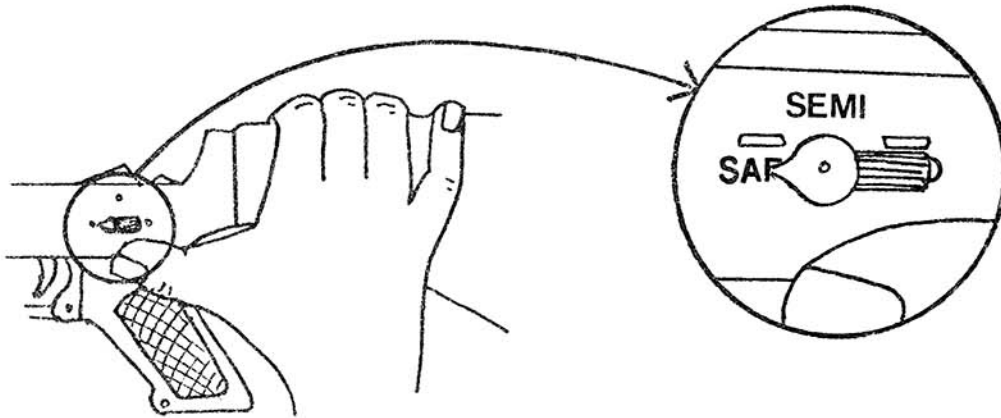

STEP 2: Close the receivers and push the takedown pin all the way up with your finger.

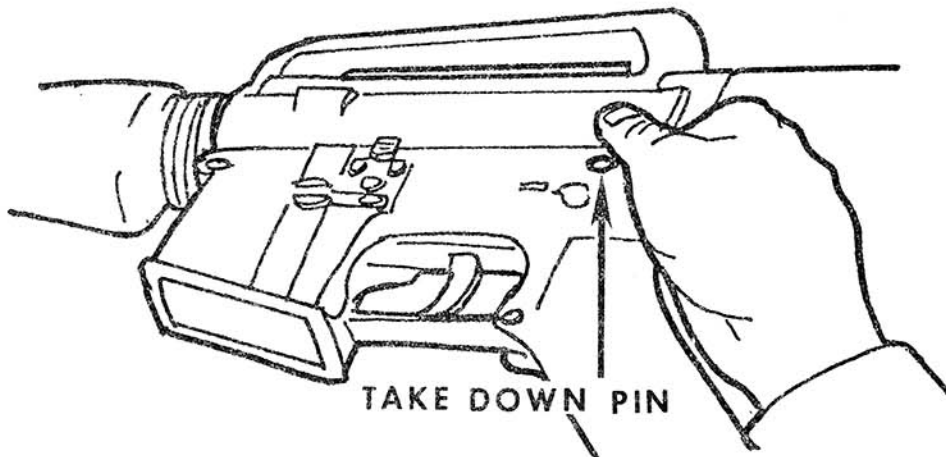

STEP 3: Put selector lever on SEMI.

STEP 4: CLEAR the weapon.

You should be able to do all these checks in less than 2 minutes.

Practice the steps for performing the functional check on the M16A1 rifle until you can do all the checks without looking at this lesson, and within 2 minutes:

1. Clear the weapon
2. Check the safe position
3. Check the semi position
4. Check the auto position
5. Finish the functional check

THEN ASK YOUR SUPERVISOR TO
GIVE YOU THE POSTTEST.

Doc. Identification: 01000000 000000 000000 000000 000000 000000 000000 000000 000000 000000

Army-Fort Lee, VA-11974-82-8105-C