

PRELIMINARY OPERATION AND MAINTENANCE MANUAL

---

OPERATION, MAINTENANCE, REPAIR  
AND  
REPLACEMENT PARTS

# SUBMACHINE GUN, 5.56-MM, XM177E2

JUNE 1980

---

## DRAFT COPY

This publication is NOT available through AG publication channels.



**HEADQUARTERS**  
**U. S. ARMY WEAPONS COMMAND**

ROCK ISLAND ARSENAL

ROCK ISLAND, ILLINOIS

Digitized by:

**SMALL ARMS** | OF THE WORLD  
SMALLARMSOFTHEWORLD.COM

## CHAPTER I

### INTRODUCTION

#### Section I. PURPOSE AND SCOPE

1-1. General.

1-2. This manual is a supplement to TM 9-1004-249-14 and contains additional pertinent information for the guidance of personnel responsible for the maintenance of the Submachine Gun, 5.56-MM XM177E2. Maintenance procedures relating to the submachine gun that are identical to the M16A1 rifle are referenced to TM 9-1005-249-14 dated 1 August 1966 including Changes 1 dated 6 Jan. 1967.

1-3. Maintenance Allocation.

1-4. Refer to appendix B.

#### Section II. DESCRIPTION

1-5. Description.

1-6. The submachine gun (fig. 1-1) is similar to the M16A1 rifle, however it has a shorter barrel and hand guard, a telescoping butt stock and different type flash suppressor.

Figure 1-1. Submachine Gun 5.56-MM, XM177E2.

WE 16879

#### Section III. TABULATED DATA

1-7. Tabulated Data.

1-8. The tabulated data listed below is peculiar to the submachine gun. For additional data refer to TM 9-1005-249-14.

##### Weight

Empty ..... 6.1 lb.

Loaded (20 round magazine) ..... 6.8 lb.

##### Length

Stocked closed ..... 29.7 in.

Stock extended ..... 33.0 in.

Barrel ..... 11.5 in.

Barrel w/flash suppressor ..... 15.0 in.

##### Firing Characteristics

Muzzle velocity ..... 2770 ft. per sec.

Cycle rate of fire ..... 650-900 rds. per min.

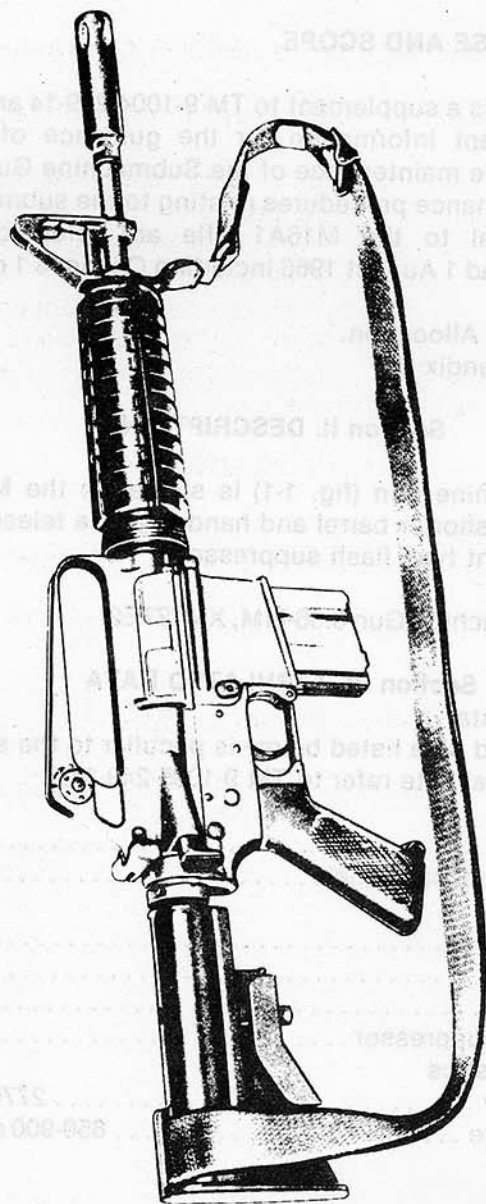

Figure 1-1 Submachine Gun, 5.56-MM, XM177E2

WE 16879

## CHAPTER II

### OPERATING INSTRUCTIONS

#### Section I. SERVICE UPON RECEIPT OF MATERIAL

- 2-1. General
- 2-2. Submachine gun is packed ready for use upon receipt.
- 2-3. Services.
  - A. Remove submachine gun from container and remove protective paper and paper bore tube.
  - B. Wipe exterior of weapon with a clean cloth, then run a clean dry patch through bore to remove oil and dirt.
  - C. Check basic issue items list with listing in appendix A.
  - D. A record will be made of all missing parts, tools and equipment and for any malfunctions. Corrective action will be initiated as quickly as possible.

#### Section II. CONTROLS

- 2-4. General.
  - A. Refer to figure 3-2 of TM 9-1005-249-14.
  - B. Refer to figure 2-1 for controls peculiar to submachine gun.

Figure 2-1. Submachine Gun, 5.56-MM, XM177E2 — Controls.  
WE 14269

#### Section III. OPERATION

- 2-5. General.
- 2-6. Refer to TM 9-1005-249-14, paragraphs 3-1, 3-2, and 3-9 through 3-19.

## MAINTENANCE INSTRUCTIONS

Section I. BASIC ISSUE ITEMS, REPAIR PARTS,  
TOOLS AND EQUIPMENT

- 3-1. Basic Issue Items.
- 3-2. Refer to appendix A of this manual for basic issue items.
- 3-3. Repair Parts.
  - A. A listing of repair parts peculiar to the submachine gun is shown in appendix C of this manual.
  - B. Refer to TM 9-1005-249-14, chapter IX, for additional repair parts.
- 3-4. Tools and Equipment.
  - A. A listing of tools and equipment peculiar to the submachine gun is shown in appendix C of this manual.
  - B. Refer to TM 9-1005-249-14, chapter IX, for additional tools and equipment.

## Section II. CLEANING AND LUBRICATION

- 3-5. Cleaning and Lubrication Instructions.
- 3-6. Follow the procedures listed in paragraphs 3-5 through 3-8, 3-25 through 3-28, and 8-10 through 8-12 of TM 9-1005-249-14, however, in the place of PL special lubricating oil and rifle grease (lubriplate) for lubricating the submachine gun, use semifluid lubricating oil, (LSA) (FSN 9150-889-3522).
- 3-7. Clean slides of extended stock and receiver extension and apply a small amount of semifluid lubricating oil (LSA) (FSN 9150-889-3522).

## Section III. PREVENTIVE MAINTENANCE SERVICES

- 3-8. General.
- 3-9. Follow the procedures listed in paragraphs 4-1 through 4-6 and table 4-1 of TM 9-1005-249-14.

## Section IV. TROUBLESHOOTING

- 3-10. General.
- 3-11. Follow the procedures listed in paragraphs 8-1 through 8-7 and table 8-1 of TM 9-1005-249-14. See table 3-1 for troubleshooting peculiar to submachine gun.

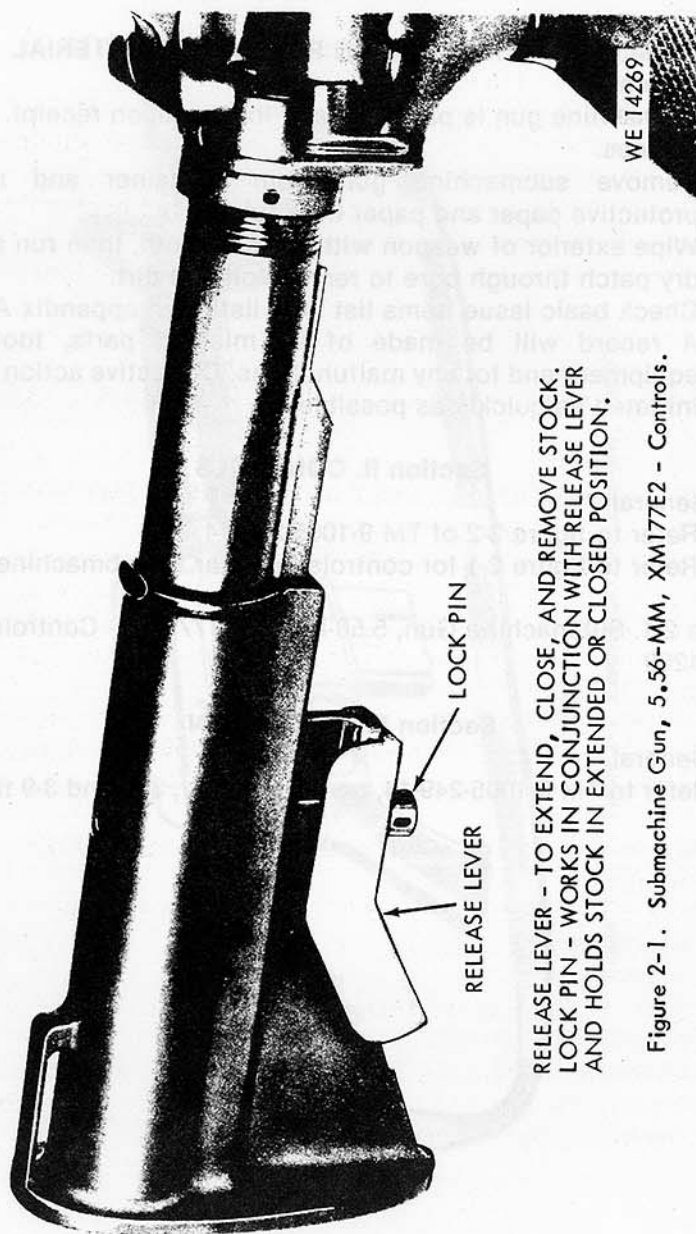

RELEASE LEVER - TO EXTEND, CLOSE, AND REMOVE STOCK.  
 LOCK PIN - WORKS IN CONJUNCTION WITH RELEASE LEVER  
 AND HOLDS STOCK IN EXTENDED OR CLOSED POSITION.

Figure 2-1. Submachine Gun, 5.56-MM, XM177E2 - Controls.

Table 3-1. Troubleshooting

Malfunction	Probable cause	Corrective Action
Flash suppressor	Excessive carbon buildup.	Clean with bore brush and bore cleaner and wipe dry.
Stock butt sliding	Sand, dirt and foreign matter which prevent sliding of stock.	Clean and dry.

**Section V. REPAIR OPERATIONS**

**3-12. Disassembly and Assembly**

- A. Follow procedures listed in paragraphs 3-23 and 3-24 of TM 9-1005-249-14, for disassembly and assembly for Operator and Organizational Maintenance.
- B. Follow procedures listed in paragraphs 8-8 and 8-9 of TM 9-1005-249-14 for disassembly and assembly for Direct and General Support Maintenance.
- C. Refer to figure 3-1 for further disassembly and assembly.

Figure 3-1. Disassembly/Assembly of Submachine Gun (Page 1 of 3). WE 14270A

Figure 3-1. Disassembly/Assembly of Submachine Gun (Page 2 of 3). WE 14271A

Figure 3-1. Disassembly/Assembly of Submachine Gun (Page 3 of 3). WE14272A

**3-13. Inspections.**

- A. Refer to paragraph 3-29 of TM 9-1005-249-14, for function check by operator and organizational maintenance and to chapter VII, paragraph 7-1 through 7-16 and chapter VIII, paragraph 8-13 and 8-18 for inspection by Direct and General Support Maintenance.
- B. Additional inspections are as follows:
  - (1) Check functioning of stock to make certain it extends and closes freely.
  - (2) Check release level for functioning.

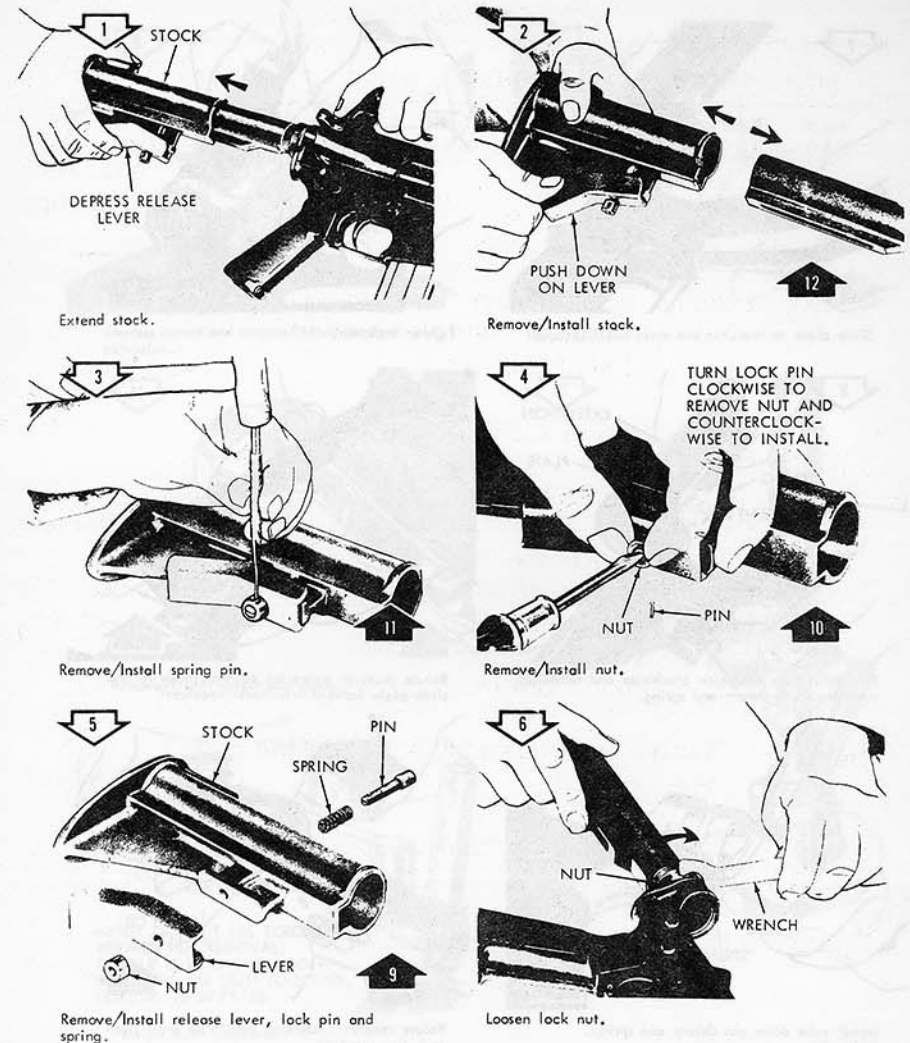

Figure 3-1. Disassembly/Assembly of Submachine Gun. (Page 1 of 3)

WE 14270A

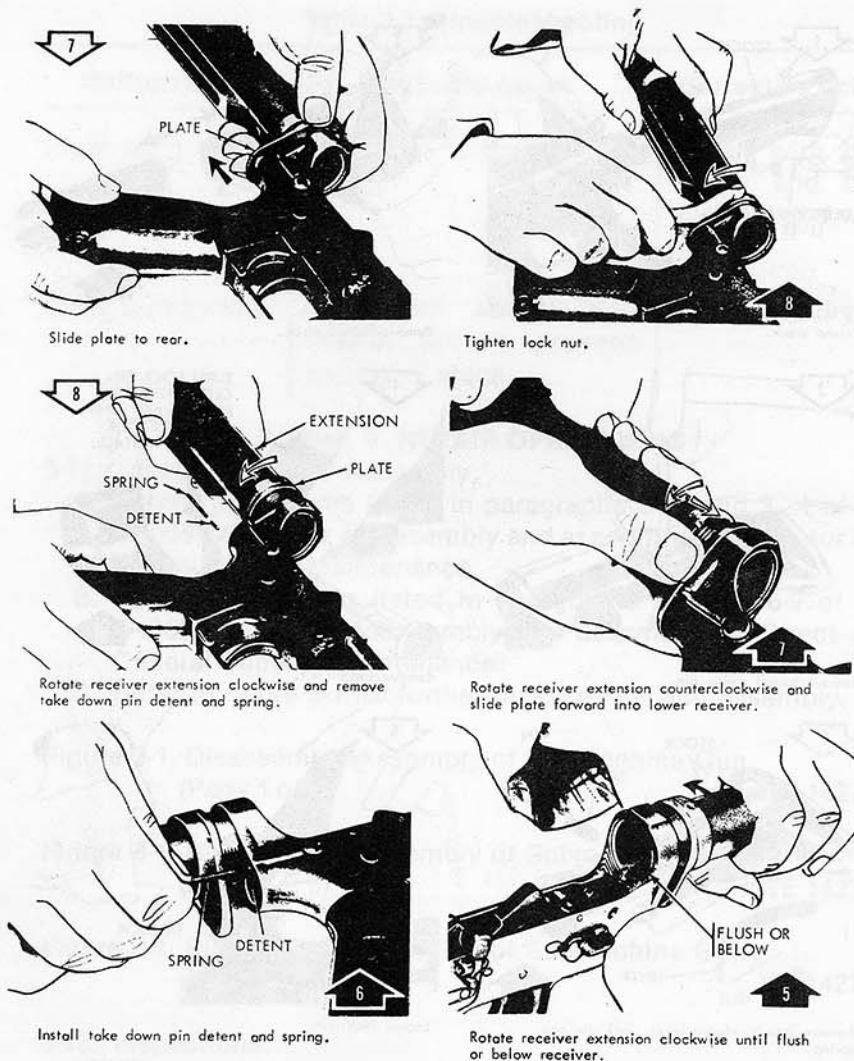

Figure 3-1. Disassembly/Assembly of Submachine Gun. (Page 2 of 3)

WE 14271A

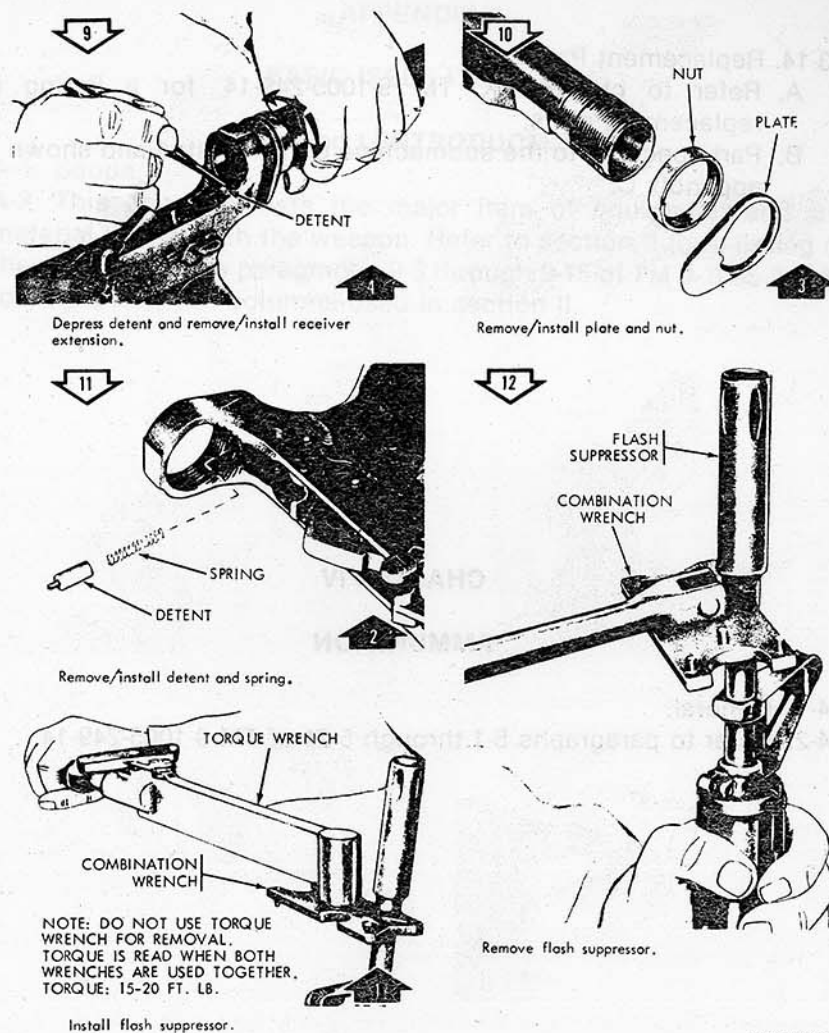

Figure 3-1. Disassembly/Assembly of Submachine Gun. (Page 3 of 3).

WE 14272A

3-14. Replacement Parts.

- A. Refer to chapter IX, TM 9-1005-249-14, for a listing of replacement parts.
- B. Parts peculiar to the submachine gun are listed and shown in appendix C.

**CHAPTER IV  
AMMUNITION**

4-1. General.

- 4-2. Refer to paragraphs 5-1 through 5-21 of TM 9-1005-249-14.

**CHAPTER V**

**DESTRUCTION OF MATERIAL TO PREVENT ENEMY USE**

5-1. General.

- 5-2. Refer to paragraphs 6-1 through 6-11 of TM 9-1005-249-14.

**APPENDIX A**

**BASIC ISSUE ITEM LIST**

**Section I. INTRODUCTION**

A-1. Scope.

A-2. This appendix lists the major item of equipment and the material issued with the weapon. Refer to section II for a listing of these items and to paragraphs 9-3 through 9-15 of TM 9-1005-249-14 for explanation of columns used in section II.

ORG	LEVEL	QUANTITY	REMARKS	DESCRIPTION
CG				
1A				
1B				
1C				
1D				
1E				
1F				
1G				
1H				

## Section II. BASIC ISSUE ITEMS

FIG NO.	MAINTENANCE LEVEL	FEDERAL STOCK NUMBER	DESCRIPTION
1-1	R	1005-021-2429	The major item listed below is requisitioned for initial issue. <b>Submachine Gun, 5.56-MM: XM177E2 w/e (8436751)</b> Composed of: 1 — <b>Submachine Gun, 5.56-MM: w/magazine assembly (20 cartridge capacity) (XM7310)</b> 1 — <b>Brush, Cleaning, Small Arms: bore (11686340)</b> 1 — <b>Brush, Cleaning Small Arms: changer (8432358)</b> 1 — <b>Case, Lubricant: (7790995)</b> 6 — <b>Magazine Assembly: aluminum (20 cartridge capacity) (62103)</b> 1 — <b>Rod, Cleaning, Small Arms: M11E2 (11686455)</b> 1 — <b>Sling, Small Arms: (7149749)</b>
*1-7		1005-903-1296	
*1-12		1005-999-1435	
*1-5		1005-791-3377	
*9-2-1		1005-056-2237	
A-1		1005-999-2035	
C-3		1005-714-9749	

\*See TM 9-1005-249-14

Figure A-1. Small arms cleaning rod M11E2 — 11686455

WE14345

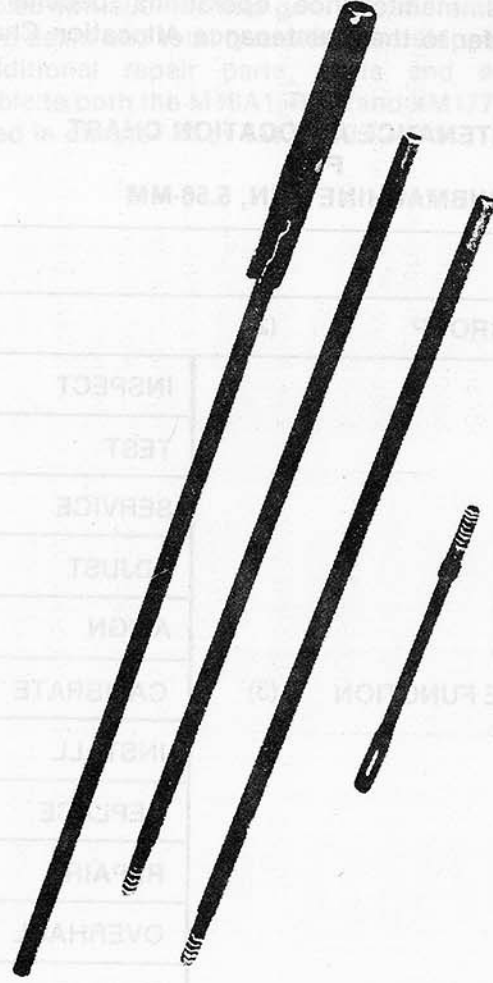

WE 14345

Figure A-1. Small Arms Cleaning Rod M11E2 - 11686455.

**APPENDIX B**

**MAINTENANCE ALLOCATION CHART**

B-1. General.

B-2. Refer to chapter X and groups 1 through 7 of Maintenance Allocation Chart in TM 9-1005-249-14.

B-3. For additional maintenance operations peculiar to the submachine gun refer to the Maintenance Allocation Chart listed below.

**MAINTENANCE ALLOCATION CHART  
FOR  
SUBMACHINE GUN, 5.56-MM**

GROUP NO.	(1)	8	
FUNCTIONAL GROUP	(2)	Stock	
MAINTENANCE FUNCTION	(3)	INSPECT	2
		TEST	
		SERVICE	1
		ADJUST	
		ALIGN	
		CALIBRATE	
		INSTALL	3
		REPLACE	3
		REPAIR	3
		OVERHAUL	
	REBUILT		
TOOLS & EQUIP.	(4)		
REMARKS	(5)		

B-1

**APPENDIX C**

**MAINTENANCE REPAIR PARTS AND TOOLS**

**Section I. PREFACE**

C-1. Scope.

C-2. This appendix lists those parts, tools and equipment, peculiar to the 5.56-mm submachine gun. These items are purchased on a one time basis and total quantities are shipped with the weapons.

C-3. Additional repair parts, tools and equipment, that are applicable to both the M16A1, Rifle and XM177E2, Submachine Gun are listed in chapter IX of TM 9-1005-249-14.

C-1

## Section II. REPAIR PARTS PECULIAR TO SUBMACHINE GUN 5.56-MM

Federal Stock No.	Part No.	Description	Figure No.	Item No.
1005-087-9009	XM7318	BARREL AND SIGHT ASSEMBLY:	C-1	14
1005-087-9008	XM7317	BARREL NUT ASSEMBLY:	C-1	17
1005-914-4578	62382	BUFFER ASSEMBLY:	C-1	6
1005-914-2922	62346	CAP, HAND GUARD:	C-1	15
1005-087-9005	XM7316	COVER, EJECTION PORT:	C-1	21
1005-914-2929	62356	EXTENSION, LOWER RECEIVER:	C-1	8
1005-914-4572	62381	HANDGUARD ASSEMBLY:	C-1	11
1005-087-8983	XM7089	LATCH, CHARGING HANDLE:	C-1	22
1005-087-8987	XM7098	LEVER, RELEASE:	C-1	2
5310-917-1215	62368	NUT, LOCK PIN:	C-1	1
5310-917-1153	62357	NUT, RECEIVER EXTENSION:	C-1	10
1005-087-8984	XM7093	PIN, EJECTION PORT COVER:	C-1	20
1005-914-3229	62361	PIN, LOCK, RELEASE LEVER:	C-1	3
1005-914-2942	62358	PLATE, END, RECEIVER:	C-1	9
1005-087-9002	XM7306	RECEIVER, UPPER:	C-1	23
1005-087-8998	XM7101	RING, SLIP, HANDGUARD:	C-1	19

## Section II. REPAIR PARTS PECULIAR TO SUBMACHINE GUN 5.56-MM — Continued

Federal Stock No.	Part No.	Description	Figure No.	Item No.
1005-914-4564	62373	SPRING, ACTION:	C-1	7
1005-916-9178	62369	SPRING, HELICAL COMPRESSION: locking	C-1	4
1005-087-8986	XM7095	SPRING, SLIP, RING HANDGUARD:	C-1	18
1005-087-8988	XM7099	STOCK, BUTT, SLIDING:	C-1	5
1005-914-3902	62370	SUPPRESSOR, FLASH:	C-1	12
1005-914-3504	62366	TUBE, GAS ASSEMBLY:	C-1	16
1005-087-9001	XM7128	WASHER, SUPPRESSOR:	C-1	13

Figure C-1. Repair Parts Peculiar to Submachine Gun 5.56-MM, XM177E2

WE 14346

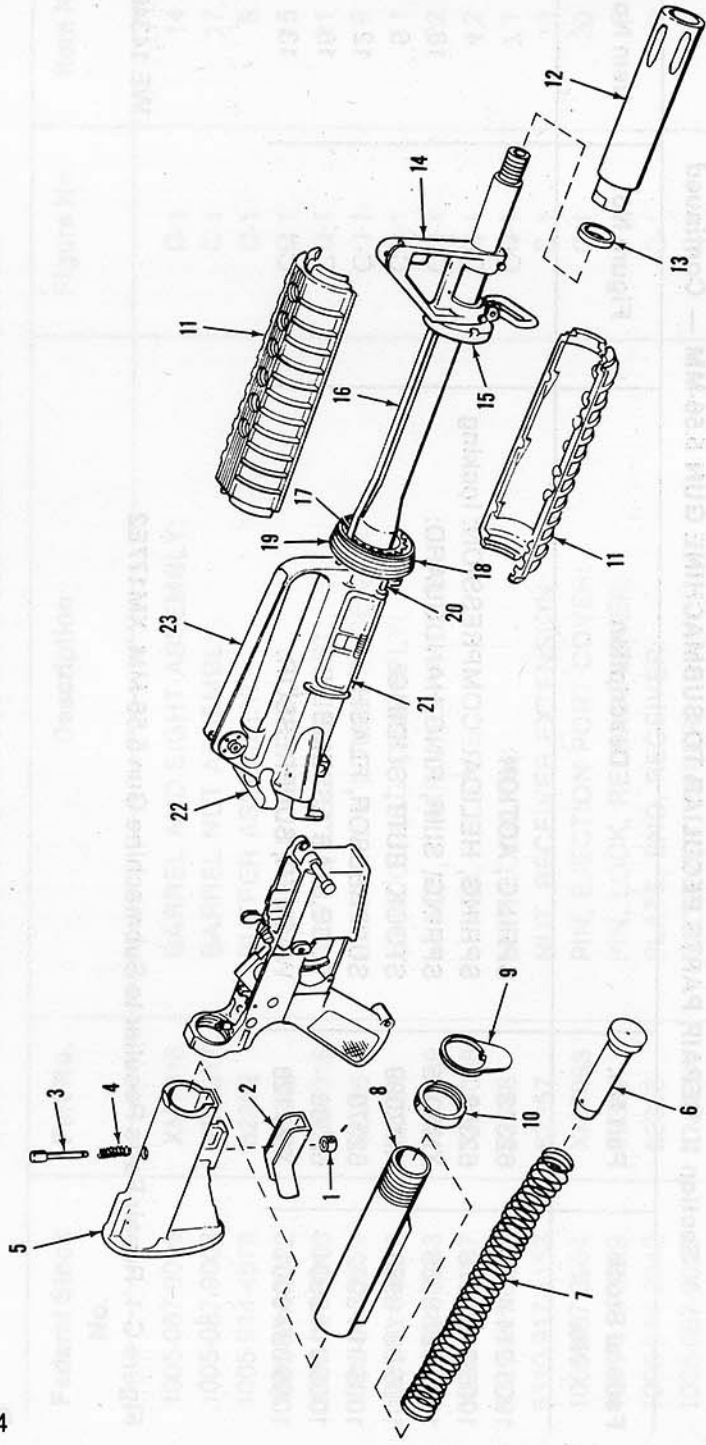

WE 14246

Figure C-1. Repair Parts Peculiar to Submachine Gun 5.56-MM, XM177E2.

## Section III. TOOLS AND EQUIPMENT PECULIAR TO SUBMACHINE GUN 5.56-MM

Federal Stock No.	Part No.	Description	Figure No.	Item No.
*5120-596-4005	8139468	WRENCH, SPANNER:	C-2	—
1005-714-9749	7149749	SLING, SMALL ARMS:	C-3	—

\* Note. Obtain from GSA Supply Catalog GC 5120-ML-A.

Figure C-2. Spanner Wrench.

WE 14273

Figure C-3. Sling, Small Arms.

WE 16884



WE 14273

Figure C-2. Spanner Wrench.



WE 16884

Figure C-3. Sling, Small Arms - 7149749.