

Meeting The Demands Of The 21st Century

OLYMPIC ARMS, INC.

2005 Dealer Catalog

TACTICAL RIFLES

BARRELS

PISTOL CALIBER RIFLES

AR PARTS

RECEIVERS

TARGET RIFLES

SERVICE RIFLES

PISTOLS



TACTICAL ACCESSORIES

624 Old Pacific Hwy SE
Olympia, WA 98513

(800) 228 - 3471
www.olyarms.com

Supporting American Freedom Since 1975

DIGITIZED FOR
YOUR REVIEW AT
WWW.SMALLARMSOFTHEWORLD.COM

SAW

Table Of Contents

	Page
Rifles (pages 3 - 20):	
UM-1P / UM-1 Ultramatch Rifles	4
SMP / SM Service Match Rifles	5
ML-1 / ML-2 Multimatch Rifles	6
K4B / K4B-A3 / K4B-UR	7
Plinker Plus 20 / Plinker Plus	8
K3B / K3B-UR / K3B Alternate Calibers	9
K3B-MIL4 / K3B-MIL4-A3 / K3B-MIL4-TC	10
K3B-CAR / K3B-FAR / K3B-FAR-UR	11
K7 Eliminator	12
LTF / LT-MIL4 Lightweight Tactical Rifles	13
K8 Target Match Rifles	14
K16 / K30 Carbine	15
K9 / K10 / K40 / K45 Pistol Caliber Carbines	16
Glock® Lower Receiver Pistol Caliber Rifles	17
OA-93 Carbine	20
AR Pistols:	
OA-98	19
OA-93	20
Standardized Rifle Options Listing	18
Upper Receiver Kits	21-22
Pistol & Rifle Caliber Conversion Kits	23
Pistol Caliber Conversion Parts	24
22+17 Solution Rifle Conversion Kit	25
Barrel Kits	26
AR Style Buttoned & Ultramatch Barrels	27-28
PCR Rifle & Carbine Kits	29
AR Upper & Lower Receivers	30
AR Parts	31-35
Aluminum Tubular & FIRSH Handguards	36-37
Ergo® Brand Accessories	38
ACE® Brand Specialty Stocks	39
AC4 Pneumatic Recoil Buffer / Tri-Pod Grip	40
Prop Guns & Training Aids	41
Owners Manuals / Airsoft	42
AR & PCR Gunsmithing Tools	43
Cleaning & Lubricating Products	44
Olympic Arms Official Accessories	45
AR Style Rifle Replacement Parts (Exploded View & Listing)	46-47
1911 Pistols (pages 48-55):	
Whitney Wolverine	49
Matchmaster 5" & 6"	50
Enforcer / Cohort	51
Westerner	52
Trail Boss / Constable	53
Street Deuce / Journeyman	54
Blak-Tac Matchmaster	55
Schuetzen Pistol Works Specialty Shop Listing	56
Fast Action Safety / Alternate Caliber Pistol Barrels	57
1911 Parts	58
1911 Slides / Top Ends / National Match Bull Barrels	59
1911 Frames	60
1911 Replacement Parts (Exploded View & Listing)	61
Whitney Wolverine Replacement Parts (Exploded View & Listing)	62
Ultramag / Ultramag Replacement Parts (Diagram & Listing)	63
Testimonials	64
About Our Retail Storefront	65

Olympic Arms Lifetime Warranty

Our goal at Olympic Arms is to lead the industry in customer service and satisfaction. For this reason, we are proud to offer the most comprehensive factory warranty of its kind. We will warranty all parts and products manufactured by Olympic Arms against any and all manufacturer's defects in materials and workmanship, which affect the satisfactory operation of the item being warranted. This warranty is non-transferable.

Beyond warranty, we guarantee complete customer satisfaction. If you are not completely satisfied with the purchase of any Olympic Arms product for any reason, simply return it to us within sixty (60) days for a replacement, credit, or refund of the original purchase price (to be decided by Olympic Arms). If you purchased your product directly from Olympic Arms, simply return the product with a copy of the original invoice to qualify. If your purchase was made through one of the thousands of Olympic Arms retailers / dealers, then they (the retailer / dealer) have the option to return the product to Olympic Arms for a replacement, credit, or refund as well. Olympic Arms does not dictate the in-store policies of all our retailers / dealers. Check with your retailer / dealer for their policy before purchasing.

The liability of Olympic Arms is limited to repair or replacement of only those parts determined by our expert staff to be defective on the part of the factory. The decision to repair or replace a warranted product will be made by Olympic Arms as necessary to provide the customer with a properly operating finished product. Olympic Arms assumes no liability for accidental or consequential damages. The following items are specifically *excluded* from coverage under this warranty:

- Normal wear of the protective finishes and of all metal or plastic parts.
- Damage or malfunction resulting from accident, negligence, misuse, or unauthorized repair or alteration.
- Damage or malfunction resulting from barrel obstructions.
- Damage or malfunction resulting from use of other than factory SAAMI specification brass cased new production ammunition.
- Damage resulting from the use of *ANY* imported, hand loaded, reloaded, or factory re-manufactured ammunition.
- Any finished products that are *NOT* assembled at the factory, or are assembled using imported or used parts. This includes completed rifle kits, pistol kits, upper receivers, lower receivers, barrel units / assemblies, etc.
- Any damage to Olympic Arms parts or components during assembly by an individual, organization, company, or entity other than Olympic Arms.

Open Letter From Olympic Arms:



In 1776 when this nation began its quest for freedom, the most important person in the village was not the mayor, or civic leaders. It was not the dry goods vendor or even the Parson. It was the blacksmith. And why? Because the blacksmith, with his ability to manufacture firearms, as well as fix and repair existing weapons, had the unique ability to allow a man to not only put food on the table, but also to defend himself, his family and his home from any aggressor be they four-legged beasts seeking to steal your livestock, or two-legged beasts seeking to steal your freedom and independence.

Olympic Arms functions in many ways the just as the blacksmith did over 200 years ago. It was the blacksmith, through first hand experience and dealing with actual customers who used his product, that was able to meet their every need through alternative design and product innovation. That's what we do best. Alternative design and product innovation have always been our specialties.

Being a true manufacturer, just in the same way as the blacksmith was 200 years ago, we can provide a product that is innovative, of high quality, and on the cutting edge of design and technology to meet our customers needs and desires. We have been doing this for almost 30 years now, and we continue to do it today.

This past year has been an exciting one. We continue to grow and expand. We have added 3 more new state-of-the-art CNC machine stations in 2003, and our growth just seems to keep going. Our product research and development department is headed by Corporate Vice President Brian Schuetz who also happens

to be my son. He is assisted by 20 year employee and Master Gunsmith Steve Houseman, and they have been kept busy to say the least. The short list of new products developed in 2003 included two more world firsts!

The first AR15 based rifles chambered in the new Winchester Super Short Magnum® cartridges are now shipping. The worlds first 30 Carbine Caliber AR15 is now out (which by the way was developed for a requirement of the Israeli Defense Forces). We continue to lead the industry in product upgrades and technology with things like Maxhard and Blak-Tac.

Rest was something that the local blacksmith didn't get much of. Always on demand when his help was needed, we have done the same for our military, our Special Forces Groups, as well as our nations civilians for 29 years and counting. As long as there's work to do, we won't rest either.

Robert C. Schuetz
President/CEO Olympic Arms, Inc.

Ordering Instructions

We take pride in our customer service team, which consists of the most courteous and knowledgeable staff in the industry. Our office and retail storefront are open Monday through Friday, from 7:00 a.m. until 4:30 p.m. Pacific Standard Time.

Phone (800) 228 - 3471 • Fax (360) 491 - 3447
www.olyarms.com For 24/7 Ordering

How To Order

A retail customer is any individual who is not an Federal Firearms Licensed (FFL) Dealer. All retail customer orders are accepted by telephone, mail, fax, or e-mail. Customers can also order certain items from our online store, please visit our website for more details. Orders must include: full name with shipping address (PO Box address are NOT accepted), day time and business phone and fax numbers if available, a method of payment arrangements, and a complete description of the products ordered to include item and/or stock numbers. Dealer orders will NOT be accepted under the name of anyone other than those people who are named on the FFL or those not designated by the Licensee. No exceptions to these policies will be made.

Shipping And Handling Fees

All shipping and handling fees are billed on a flat rate scale based on the total dollar amount of each invoice. Each separate box required for shipping, will be shipped via a separate shipping invoice. Shipping and handling charges are taxable to Washington State residents. The scale for determining shipping and handling charges are as follows:

\$0.01 - \$99.99	\$7.95
\$100.00 - \$499.99	\$14.95
\$500.00 - 999.99	\$20.00
\$1000.00 & Up	\$27.00
COD	\$6.25 Extra per invoice.

Methods Of Payment

We will accept COD, credit card, or pre-paid orders. All COD orders will be shipped on a certified-funds-only basis. To receive a 'COD Check OK' status, a bank reference must first be filed with the Olympic Arms accounting department. At the time of a bank reference filing all 'COD Check OK' account will be approved for future shipments pending approval by our accounting department.

The following major credit cards are accepted: American Express, Discover Card, Master Card, and VISA. Credit card accounts are not charged until the order is shipped. Pre-paid orders are accepted, however, orders paid by personal check or company check may be held until the funds clear the bank. This process could delay your order as much as ten to fourteen (10-14) days. All orders from within the state of Washington will be charged a seven-point-eight percent (7.8%) sales tax. Sales taxes for Washington state orders are waived if a Washington State Department of Revenue resale certifi-

cate is on file with our accounting department. The Olympic Arms accounting department does NOT offer 'open' accounts of any type.

Returns

All returns must be sent to:
Olympic Arms, Inc.
Att: Returns & Repairs
624 Old Pacific Hwy SE
Olympia, WA 98513

Please be sure that you include a personal and company name, a return address (again PO Boxes are not acceptable), a daytime phone number, a copy of the original invoice, as well as a letter detailing the reason for the return. All of these items must be included with a return to ensure prompt processing of an returned item.

No CLASS III returns or repairs can be accepted without prior notification and proper ATF transfer. All CLASS III items sent to Olympic Arms without advance notification and the proper ATF forms will be IMMEDIATELY returned to the sender.

Warranty Repair

All returns for warranty repair must be shipped to the address specified in the 'Returns' section. Determination as to whether the problem with the returned product is covered under warranty will be made after it is inspected by the expert technical staff of Olympic Arms.

Restocking Fee

All refused or returned shipments without prior authorization are subject to payment of all shipping charges incurred by Olympic Arms, as well as a fifteen percent (15%) restocking fee. Please be sure to call to determine if a RETURN AUTHORIZATION NUMBER is required before you return any product to us. Olympic Arms is bound by all federal laws applicable to the products we manufacture and sell, including the legal transfer of such weapons. Please contact our customer service staff during business hours for confirmation of procedures.



Rifle Guide



Ultramatch Rifles - p. 4



Service Match Rifles - p. 5



Multimatch Rifles - p. 6



K4B - p. 7



Plinker Plus Rifles - p. 8



K7 Eliminator - p. 12



K3B - p. 9-11



Lightweight Tactical Rifles - p. 13



K8 - p. 14

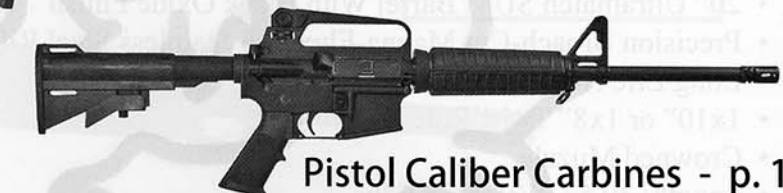

Pistol Caliber Carbines - p. 16



OA Series Rifles & AR Pistols - p. 19-21



UM-1P Premium Grade Ultramatch Rifle

UM-1P Specifications:

- All features of the UM-1
- Maxhard Picatinny Flat Top Upper
- Maxhard Premium Forged A2 Lower Receiver
- Williams Set Trigger
- Ergo Brand Tactical Pistol Grip
- Harris Brand Bi-Pod
- 20" or 24" Broach-Cut Ultramatch Bull Barrel
- ERing One Piece Gas Ring
- EXring Polymer Extractor Buffer
- ESpring Ejector Spring
- AC4 Pneumatic Recoil buffer
- Blak-Tac Armour Bolt Carrier Assembly



UM-1P:
\$1,299⁰⁰
MSRP

Building on the reputation of "the most accurate AR target rifle ever made", Olympic Arms is offering the UM-1P Premium Grade Ultramatch Rifle. This system incorporates all the exact features of the famous UM-1 Ultramatch rifle and adds a group of options and upgrades to this new standard model. Our customers expect sub 1/2" margin of accuracy from this rifle right out of the case. Also available as a completely assembled, headspaced, and test fired upper receiver unit.

rifle ever made", Olympic Arms is offering

UM-1 Ultramatch Rifle

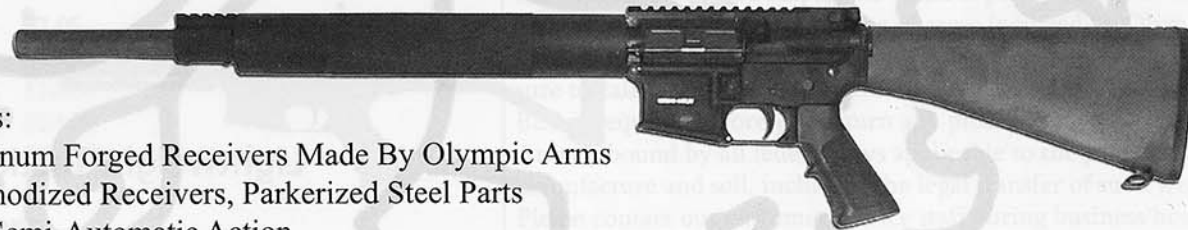

UM-1 Specifications:

- 7075 T6 Aluminum Forged Receivers Made By Olympic Arms
- Black Matte Anodized Receivers, Parkerized Steel Parts
- Gas Operated Semi-Automatic Action
- SAAMI Minimum .223 Remington Chambering
- Picatinny Flat Top Upper With Picatinny Gas Block For Sights
- 20" Ultramatch SUM Barrel With Black Oxide Finish
- Precision Broach-Cut Magna-Flux 416 Stainless Steel Rifling
- Long Life Non-Chromed Bore
- 1x10" or 1x8" Twist Rate
- Crowned Muzzle
- Length: 39.5" Weight: 8.6 lbs.

UM-1:
\$895⁰⁰
MSRP

If you are searching for accuracy at an affordable price, the UM-1 is your goal. It comes with our renown Ultramatch broach cut stainless steel barrel manufactured with reamers from Clymer allowing for optimum accuracy potential. We've seen 1/4" groups and smaller when used with the proper load, bullets, and barrel. This is the rifle SWAT Magazine called "the most accurate AR target rifle ever made." The UM-1 comes standard with bull barrel and picatinny gas block. Also available as a completely assembled, headspaced, and test fired upper receiver unit (see K6 Upper Receiver on page 20).

SM Service Match Rifle

SM Specifications:

- 7075 T6 Aluminum Forged Receiver Made By Olympic Arms
- Black Matte Anodized Receivers, Parkerized Steel Parts
- Gas Operated Semi-Automatic Action
- .223 Remington SAAMI Minimum Chambering
- National Match 1/4 MOA Adjustable Rear Sight
- Elevation Adjustable Front Post Sight
- 20" Ultramatch Super Heavy Barrel In 416 Stainless Steel
- Long Life Non-Chromed Bore
- Choice Of 1x8" or 1x10" Twist Rate
- Threaded Muzzle w/ Flash Suppressor
- High Capacity Legal Magazines
- Length: 39.5" Weight: 8.75 lbs.

SM: \$916⁰⁰
MSRP

SM-UR:
\$625⁰⁰
MSRP



The Service Match (SM) is a CMP legal service match competition rifle. The SM has the Arms 20" 416 stainless steel broach-cut Ultramatch Barrel. Standard features include 1/4 of accuracy adjustable national match rear sight system, factory tuned trigger pull smoothed to 4.5-5 lbs. Guaranteed to group sub 1" or less at 100 yards*. Also available is the SM upper receiver by itself in a fully assembled, headspaced, and test-fired unit.

Olympic margin to 4.5-5

SMP Premium Service Match Rifle

SMP:
\$1,344⁰⁰
MSRP



The Service Match Premium is the continuation of Olympic Arms line of premium rifles. This rifle has all of the standard features of the SM rifle and adds a Maxhard upper receiver, Maxhard lower receiver, and the AC4 Pneumatic Recoil Buffer. Custom front sights are attached using set screws, rather than taper pins, for a strong front sight alignment. Includes Bob Jones® National Match interchangeable rear sight system, and a Turner Saddlery® competition sling.

ML Multimatch Rifles

ML Specifications:

- 7075 T6 Aluminum Forged Receiver Made By Olympic Arms
- Black Matte Anodized Receivers, Parkerized Steel Parts
- Gas Operated Semi-Automatic Action
- .223 Remington SAAMI Minimum Chambering
- 16" Ultramatch Barrel In 416 Stainless Steel
- Long Life Non-Chromed Bore
- Choice Of 1x8" or 1x10" Twist Rate
- Aluminum Free Floating Handguards

ML-1:
\$799⁰⁰
MSRP

ML-1-UR:
\$488⁰⁰
MSRP

The ML-1 Multimatch rifle comes with an A2 upper receiver, collapsible stock, threaded muzzle with flash suppressor, fully adjustable A2 rear sight, and an elevation adjustable front sight post. This rifle is similar to the UM-1 with the difference between the two being a shorter barrel and the A2 styled upper receiver. The ML-1 is more maneuverable and a top choice for short to medium range varmint and target shooting. Also available as a completely assembled, headspaced, and test fired upper receiver unit.

ML-1 Multimatch

Length: 35.5"
Weight: 7.35 lbs.



ML-2 Multimatch

Length: 34.75"
Weight: 8.05 lbs.

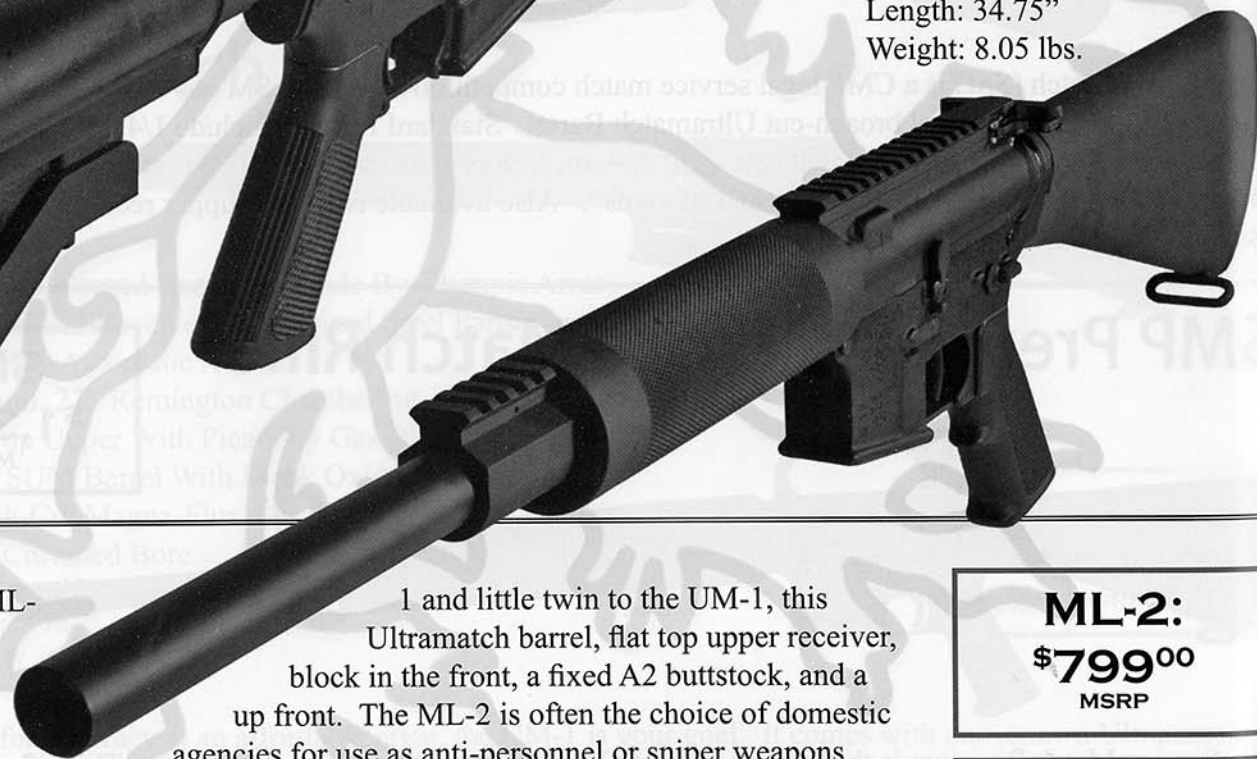

Sibling rifle to the ML-1 and little twin to the UM-1, this rifle has a 16" Ultramatch barrel, flat top upper receiver, picatinny gas block in the front, a fixed A2 buttstock, and a crowned muzzle up front. The ML-2 is often the choice of domestic law enforcement agencies for use as anti-personnel or sniper weapons when space in a squad car is limited and accuracy is required. Also available as a completely assembled, headspaced, and test fired upper receiver unit. The ML-2 is also available in A3 format which includes a detachable picatinny carry handle. Now standard with a bull barrel!

The ML-2 is often the choice of domestic agencies for use as anti-personnel or sniper weapons when space in a squad car is limited and accuracy is required. Also available as a completely assembled, headspaced, and test fired upper receiver unit. The ML-2 is also available in A3 format which includes a detachable picatinny carry handle. Now standard with a bull barrel!

ML-2:
\$799⁰⁰
MSRP

ML-2-UR:
\$488⁰⁰
MSRP

K4B

K4B Specifications:

- 7075 T6 Aluminum Forged Receiver Made By Olympic Arms
- Black Matte Anodized Receivers, Parkerized Steel Parts
- Gas Operated Semi-Automatic Action
- 5.56 NATO Caliber
- A2 Adjustable Rear Sight
- Elevation Adjustable Front Post Sight
- 20" Match Grade Button Rifled Barrel In 4140 Chromemoly Steel
- Long Life Non-Chromed Bore
- 1x9" Twist Rate
- Threaded Muzzle w/ Flash Suppressor
- Length: 39.5" Weight: 8.6 lbs.

K4B:
\$669⁰⁰
MSRP



The K4B is the industry standard with a 4140 Chromemoly steel match-grade button rifled barrel. With an A2 upper receiver, A2 handguards, and an A2 stock, this is as close to the M16A2 in a civilian variation as you can find.

K4B-A3

The same great rifle as the K4B, but add a picatinny flat top upper receiver and a detachable carry handle standard. Get fundamental versatility for your K4B when you use the picatinny mounting system.

K4B-A3:
\$748⁰⁰
MSRP

K4B-UR

The complete K4B upper receiver makes a great upgrade. Comes assembled with an A2 upper receiver, 20" match grade button rifled barrel in 4140 chromemoly steel, A2 handguards, A2 sights, threaded muzzle, flash suppressor, and bayonet lug.

K4B-UR:
\$374⁰⁰
MSRP

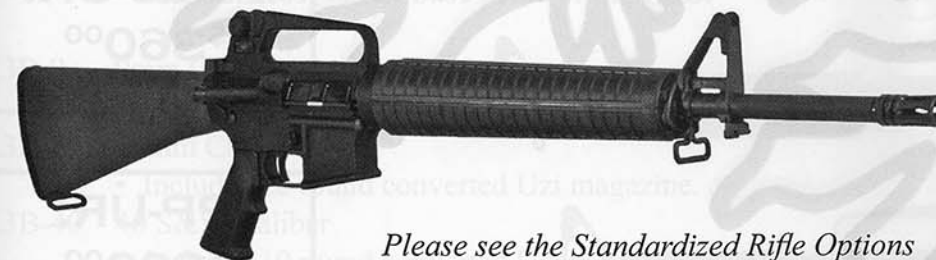

Please see the Standardized Rifle Options page for a listing of some of the options you can add to this rifle.



Detachable carry handle shown included.

Plinker Plus 20

Plinker Plus 20 Specifications:

- All Features Of Plinker Plus, Longer Barrel
- 20" Match Grade Button Rifled Barrel In 4140 Chromemoly Steel
- Length: 39.5" Weight: 8.4 lbs.

The big twin to the Plinker Plus, this rifle is a throw-back with an A1 rear sight system. This modernized A1 rifle comes with an A2 lower receiver and all of the A2 features, except for the sights. The upper receiver is forged and the forward assist and brass deflector are built right in. Standard with a 20" heavy barrel, this rifle is ready for action. At a competitive price for the budget shooter, this is the least expensive 20" barrel AR on the market, but don't forget the Olympic Arms lifetime warranty.

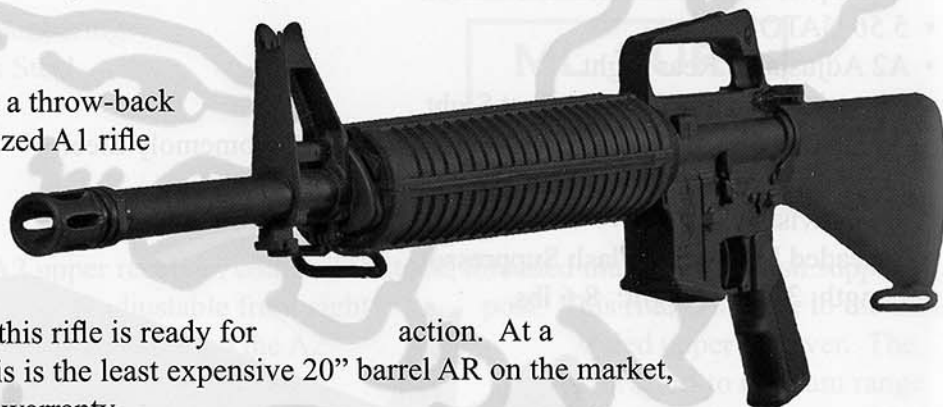

PLINKER PLUS 20:

\$624⁰⁰
MSRP

The Plinker Plus and the Plinker Plus 20 models are not available with any factory installed options.

Plinker Plus

Plinker Plus Specifications:

- 7075 T6 Aluminum Forged Receiver Made By Olympic Arms
- Black Matte Anodized Receivers, Parkerized Steel Parts
- Gas Operated Semi-Automatic Action
- 5.56 NATO Caliber
- A1 Adjustable Rear Sight
- Elevation Adjustable Front Post Sight
- 16" Match Grade Button Rifled Barrel In 4140 Chromemoly Steel
- Long Life Non-Chromed Bore
- 1x9" Twist Rate
- Threaded Muzzle w/ Flash Suppressor
- Length: 39.5" Weight: 7.0 lbs.



PLINKER PLUS:

\$589⁰⁰
MSRP

Plinker Plus Upper Receivers

All upper receiver units are factory assembled, headspaced, and test fired units only.

Bayonet lugs are standard on both Plinker models. Shown here are the Plinker model upper receivers in the 10-Year-Weapons-Ban format which have the bayonet lug removed and the muzzle crowned.



PP20-UR:

\$360⁰⁰
MSRP



PP-UR:

\$329⁰⁰
MSRP

K3B

K3B Specifications:

- 7075 T6 Aluminum Forged Receivers Made By Olympic Arms
- Black Matte Anodized Receivers, Parkerized Steel Parts
- Gas Operated Semi-Automatic Action
- 5.56 NATO Caliber
- Adjustable A2 Rear Sight
- Elevation Adjustable Front Sight Post
- 16" Match Grade Barrel In 4140 Chromemoly Steel With Precision Rifling
- Long Life Plus Non-Chromed Bore
- 1x9" Twist Rate
- Threaded Muzzle w/ Flash Suppressor
- A2 Buttstock
- Length: 34" Weight: 7.0 lbs.

The Olympic Arms 16" carbine is the rifle that will offer fun for a very long time. With Olympic Arms' match-grade barrel your K3B will start and stay accurate, outperforming other manufacturer's barrels on the market. Often described as rugged, reliable, accurate, and comfortable, this rifle occupies the trunks of hundreds of police patrol cars. Standard in a 5.56 NATO chambering, this versatile package is available in four different pistol calibers, as well as with an A3 flat top upper receiver.

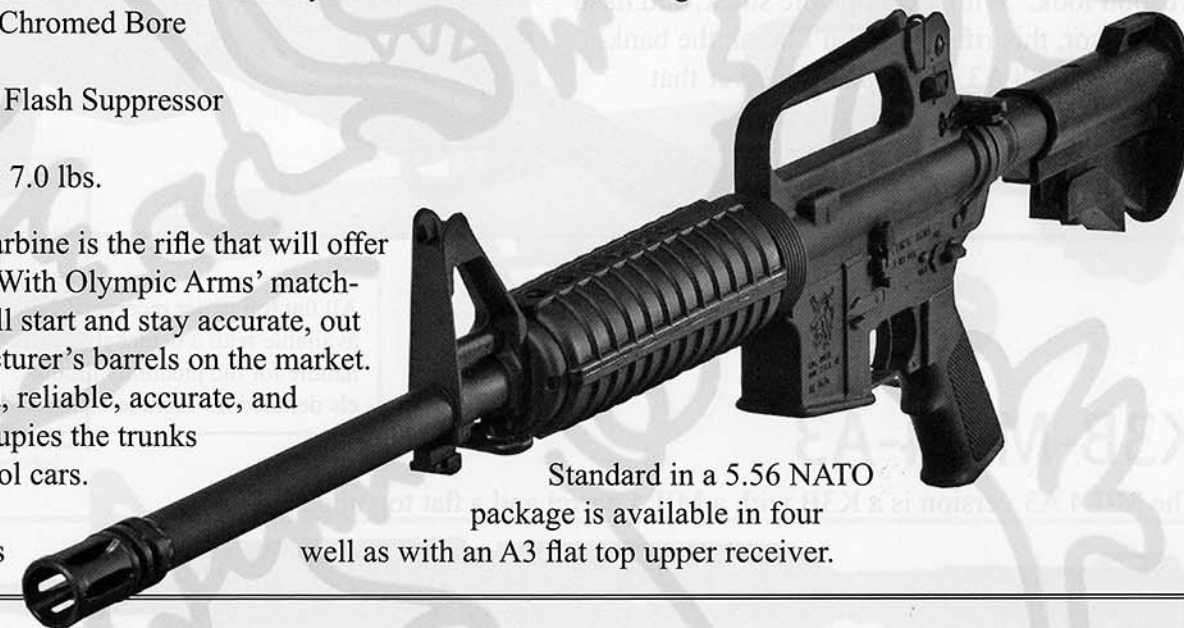

K3B:
\$629⁰⁰
MSRP

K3B-A3:
\$708⁰⁰
MSRP

K3B-UR

A completely assembled, headspaced, and test fired K3B upper receiver unit.



K3B-UR:
\$363⁰⁰
MSRP

K3B Alternate Calibers

These alternate pistol calibers are available only for the K3B base model.

Each Alternate Caliber\$66.00

- Add this cost to the base price of the K3B.

- K3B-9 9mm Caliber
 - Includes 32 round converted Sten magazine.
- K3B-10 10mm Caliber
 - Includes 10 round converted Uzi magazine.
- K3B-40 40 S&W Caliber
 - Includes 10 round converted Uzi magazine.
- K3B-45 45 ACP Caliber
 - Includes 10 round converted Uzi magazine.



High capacity magazines are only available for the 9mm caliber.

K3B-MIL4

K3B-MIL4 Specifications:

- All Features Of K3B
- Carbine Length Handguards
- Collapsible Stock
- MIL4 Barrel
- MIL4 Type Handguards

K3B-MIL4:
\$699⁰⁰
 MSRP



A rugged and reliable carbine with the assault weapon look. With a collapsible stock, and flash suppressor, this rifle still won't break the bank. Available with A3 style upper receiver that adds the versatility of a picatinny flat top and detachable carry handle.

All flat top upper receivers are available with a detachable carry handle for the picatinny mounts. Models denoted *A3* include the detachable carry handle.



K3B-MIL4-A3

The MIL4 A3 version is a K3B with a MIL4 barrel and a flat top upper receiver.

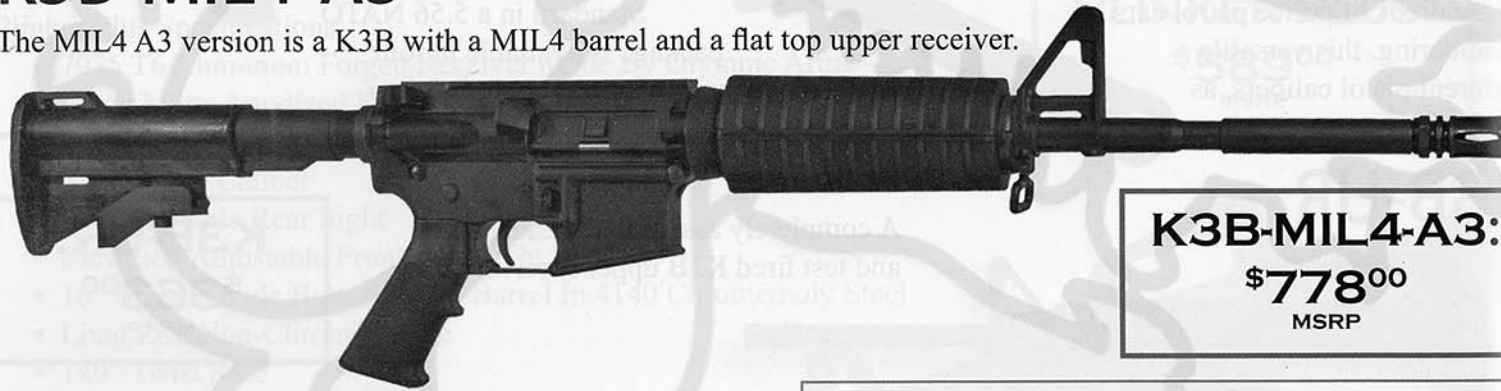

K3B-MIL4-A3:
\$778⁰⁰
 MSRP

Though not shown here, both the A3 and the TC versions of the K3B-MIL4 rifle come with bayonet lugs standard. All models are available in the 10-Year-Weapons-Ban format which have the bayonet lugs removed and the muzzles crowned.

K3B-MIL4-TC

The MIL4 Tactical Carbine version of the K3B with the Olympic Arms FIRSH handguard and a flat top upper receiver. This rifle is not only amazing to look at, but with picatinny standard rails all over there is sure to be enough mounting space for your own accessories. Includes a picatinny detachable carry handle.

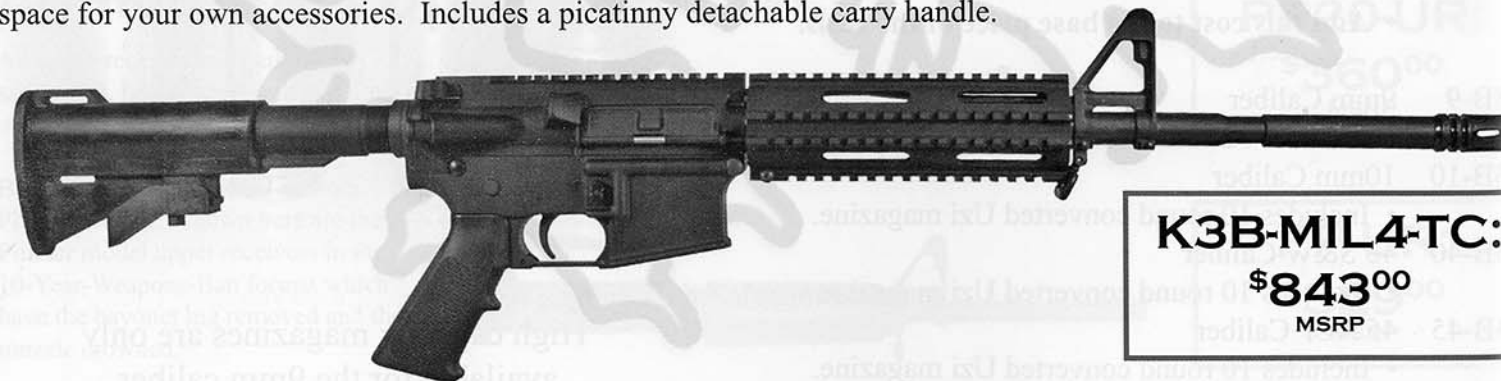

K3B-MIL4-TC:
\$843⁰⁰
 MSRP

K3B-CAR

K3B-CAR Specifications:

- All Features Of K3B
- Carbine Length Handguards
- Collapsible Stock

K3B-CAR:
\$675⁰⁰
 MSRP

K3B-CAR-A3:
\$754⁰⁰
 MSRP

A rugged and reliable carbine with the assault weapon look. With a heavy barrel, collapsible stock, and flash suppressor, this rifle still won't break the bank. Available with A3 style upper receiver that adds the versatility of a picatinny flat top and detachable carry handle.



A3 Upper Shown



Detachable carry handle shown is included.

K3B-FAR

K3B-FAR Specifications:

- Most Features Of K3B
- Smaller Barrel Diameter
- No carbon fiber or plastic substitution parts.
- All parts interchangeable with standard mil-spec quality AR parts.
- **Weight: 4.92 lbs.**



The K3B Featherweight AR (FAR) style rifle is incredibly light when you consider that there are no plastic or carbon fiber parts. If it's metal on a standard AR style rifle, it's metal on our FAR rifle. Also available with an A3 style flat top upper receiver.

K3B-FAR:
\$685⁰⁰
 MSRP

K3B-FAR-A3:
\$764⁰⁰
 MSRP

K3B-FAR-UR

A completely assembled, headspaced, and test fired K3B-FAR upper receiver unit.



K3B-FAR-UR:
\$398⁰⁰
 MSRP

K7 Eliminator

K7 Specifications:

- 7075 T6 Aluminum Forged Receivers Made By Olympic Arms
- Black Matte Anodized Receivers, Parkerized Steel Parts
- Gas Operated Semi-Automatic Action
- 5.56 NATO Caliber
- Adjustable A2 Rear Sight
- Elevation Adjustable Front Sight Post
- **16" Barrel In 416 Stainless Steel With 20" Sight Radius**
- Long Life Non-Chromed Bore
- 1x9" Twist Rate
- Threaded Muzzle w/ Flash Suppressor
- A2 Buttstock
- Length: 34.75" Weight: 4.92 lbs.

K7:
\$703⁰⁰
MSRP

K7-A3:
\$821⁰⁰
MSRP

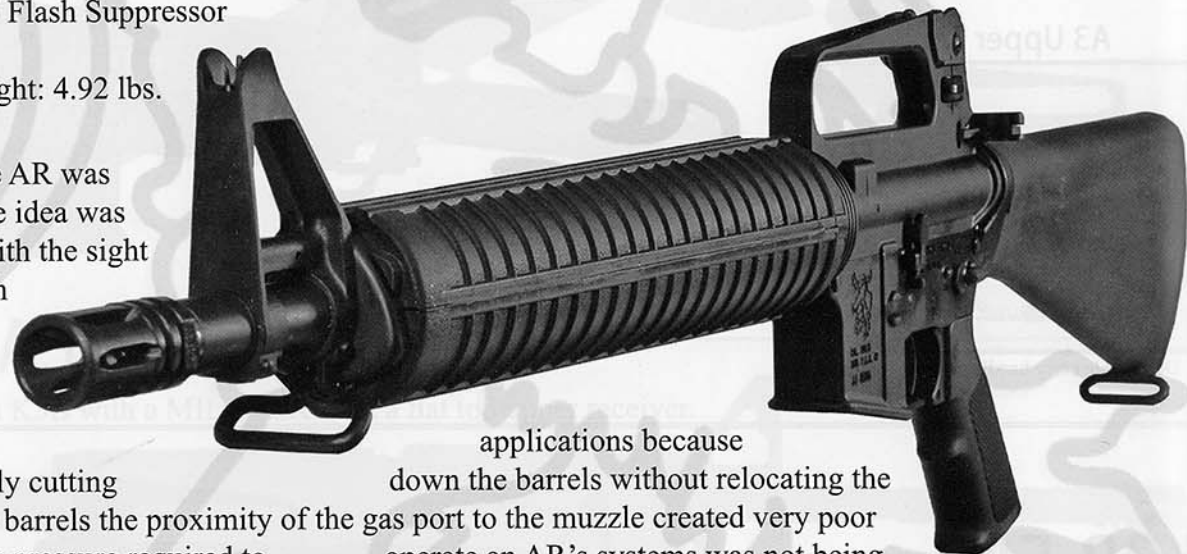

When the eliminator style AR was introduced years back, the idea was to produce a 16" barrel with the sight radius of a 20" barrel with the benefits of both in a compact form. The first eliminator barrels made had very poor manufacturers were simply cutting gas ports. On these early barrels the proximity of the gas port to the muzzle created very poor reliability because the gas pressure required to generated. At Olympic Arms we took the idea version.

applications because down the barrels without relocating the operate an AR's systems was not being and made our own properly designed

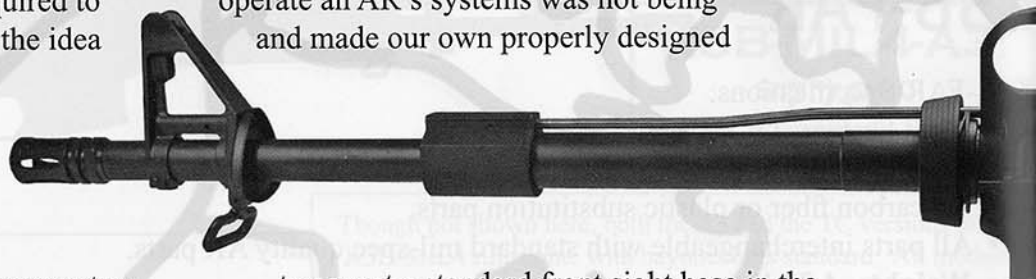

to accept a standard front sight base in the same location it would have been on a 20" barrel. Looking at our design, we have a gas block separate from the front sight base. The front sight base is not part of the gas system, but still holds the handguards and the front sight assembly. This successful Olympic Arms design has brought the

At Olympic Arms rather than cutting down a 20" barrel, we created a new 16" barrel and contoured the 16" gas system



Eliminator to a high in quality, reliable tactical AR systems.

K7-UR:
\$437⁰⁰
MSRP

The K7 Eliminator is available in the A3 style which adds a flat top upper receiver and detachable carry handle. Also, available is the K7 upper receiver as a fully assembled, headspaced, and test fired unit by itself.

LT Lightweight Tactical Rifles

LT Specifications:

- 7075 T6 Aluminum Forged Receivers Made By Olympic Arms
- Black Matte Anodized Receivers, Parkerized Steel Parts
- Gas Operated Semi-Automatic Action
- 5.56 NATO Caliber
- Adjustable, Flip-Up Sight Systems
- Long Life Non-Chromed Bores
- 1x9" Twist Rates
- Threaded Muzzles w/ Flash Suppressors
- FIRSH Handguards
- ACE® Brand FX Stocks

LTF:
\$1,010⁰⁰
MSRP

LT-MIL4:
\$942⁰⁰
MSRP

Specific for tactical uses, we with the Ergo® hand grip and almost any accessory with a

made these rifles lightweight and ready for the add-ons you need. Easy to hold soft on the arms and shoulders with the padded Ace® buttstock. You can add picatinny mount on this rifle.

LTF Fluted

Length: 35.75"
Weight: 6.8 lbs.

LT-MIL4

Length: 35.75"
Weight: 6.7 lbs.



With the flat top upper receiver and the FIRSH handguard it adds up to 33" of length. On the top of the rifle you get 12" rail length, plus 7" each on the left right barrel handguard. The flip up sights are adjustable. The rear sight is multiple aperture picatinny railing and bottom of the as well as adjustable. Each barrel is a lightweight type made from 416 Stainless Steel. Up front replacing the A2 sight is a picatinny gas block with the flip-up front sight attached to it. You choose the style that suits you. The MIL4 barrel gives the classic lightweight look, and the LTF with the fluted barrel will dissipate heat faster because it has more surface area.

K8 Target Match Rifles

K8 Specifications:

- 7075 T6 Aluminum Forged Receivers Made By Olympic Arms
- Black Matte Anodized Receivers, Parkerized Steel Parts
- Gas Operated Semi-Automatic Action
- 5.56 NATO Caliber
- Picatinny Flat Top Upper Receiver
- 20" 416 Stainless Steel Bull Barrel
- Long Life Non-Chromed Bore
- 1x9" Twist Rate
- Crowned Muzzle
- A2 Buttstock
- Length: 38.5" Weight: 8.5 lbs.



K8:
\$669⁰⁰
MSRP

K8-MAG:
\$895⁰⁰
MSRP

If the UM-1 is too much gun for your tastes, then consider the K8 rifle as an alternative. The K8 was engineered for accuracy and afford-



ability. Designed much like the UM-1, most shooters cannot distinguish between the two, and the only real difference is the barrel. Where the UM-1 has an Ultramatch barrel, the K8 has a 416 Stainless Steel button rifled barrel. Still, customers continue to expect 1/2" groups and better from 100 yards with the K8 right out of the box.



K8-MAG

K8-MAG Specifications:

- Most Features Of The K8
- Add 24" Barrel In 4140 Chromemoly Steel
- WSSM .223, .243, or .25 Calibers

Take the K8 rifle and chamber it for the new Winchester® Super Short Magnum cartridges and you've got a K8-MAG. This rifle is a flat top target grade rifle available in the .223, .243, and .25 WSSM chambering. The K8-MAG launches a 55 grain .223 bullet at 3,950 FPS, and a 55 grain .243 bullet at 4,000 FPS. Hardly the standard AR rifle, the K8-MAG is outfitted with proprietary high pressure bolts, barrel extensions, bolt carriers, and modified upper receivers. While not standard, the upper receiver will still fit and function on any standard .223/5.56 caliber lower receiver without modification to the lower receiver. Long time Olympic Arms customers spend hundreds less for the K8-MAG compared to other .308 rifles. Or you can convert your .223 caliber AR into a *MAGNUM* by ordering just the upper receiver assembly.

K8 Upper Receivers

Completely assembled, headspaced, and test fired upper receiver units.

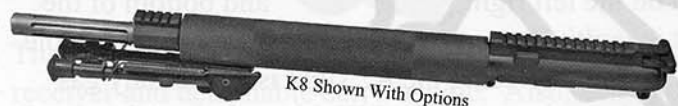

K8 Shown With Options

K8-UR:
\$415⁰⁰
MSRP

K8-MAG-UR:
\$560⁰⁰
MSRP

Optional barrel fluting and Harris® Bi-Pod shown.

K16

K16 Specifications:

- 7075 T6 Aluminum Forged Receivers Made By Olympic Arms
- Black Matte Anodized Receivers, Parkerized Steel Parts
- Gas Operated Semi-Automatic Action
- 5.56 NATO Caliber
- Picatinny Flat Top Upper Receiver
- 16" Barrel In 4140 Chromemoly Steel
- Long Life Non-Chromed Bore
- 1x9" Twist Rate
- Crowned Muzzle
- A2 Buttstock
- Length: 34.75" Weight: 4.92 lbs.

K16:
\$595⁰⁰
MSRP

K16-UR:
\$383⁰⁰
MSRP



Quickly building it's own reputation, the K16 is one of the best selling AR style rifles in the industry. This amazing little carbine comes with a free floated 16" button rifled barrel. See the Testimonial page for the two 10 shot 1/2" groups from our K16.

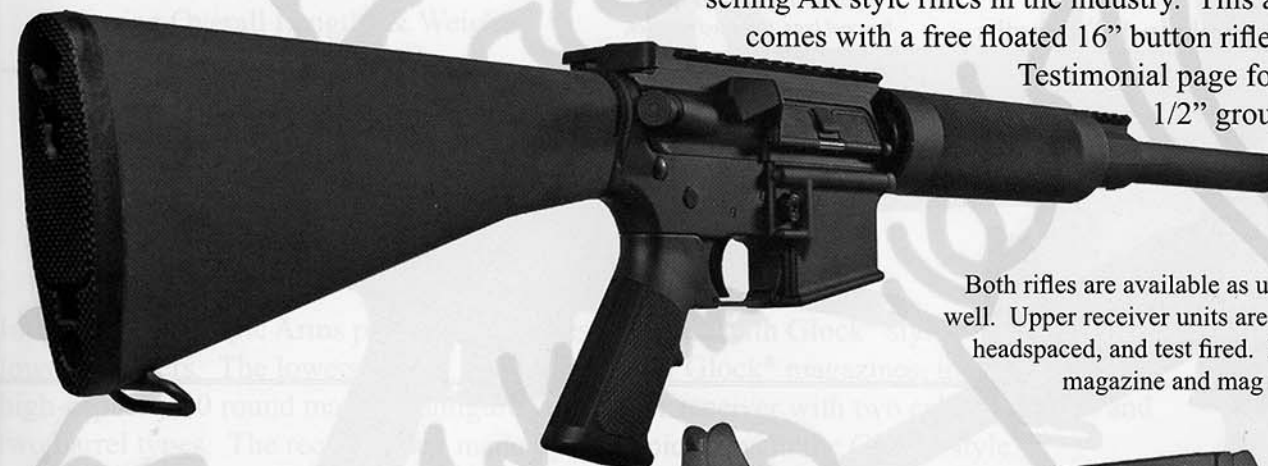

Both rifles are available as upper receiver units as well. Upper receiver units are completely assembled, headspaced, and test fired. K30-UR comes with magazine and mag catch insert.



K30 Carbine

K30 Specifications:

- Most Features Of K16 Carbine, Add:
- A2 Upper Receiver
- Collapsible Stock
- Threaded Muzzle, Flash Suppressor
- .30 M1 Carbine Caliber
- 1x12" Twist Rate
- Length: 39.5" Weight: 7.15 lbs.

30 Caliber Magazine And Insert Parts Shown

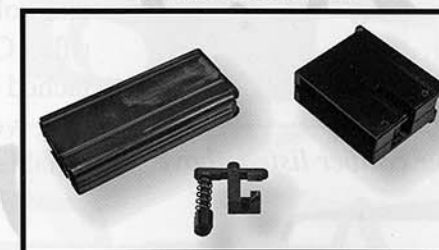

K30:
\$749⁰⁰
MSRP

K30-UR:
\$545⁰⁰
MSRP

One of the latest caliber conversion units from Olympic Arms, the K30 Carbine uses standard unmodified 30 carbine magazines. If you order just the upper receiver to convert your AR you won't need to make any modifications to your lower except for the installation of our easy-to-install magazine catch. Complete rifles come with the magazine catch already installed. Some areas limit the use of .223 caliber ammunition for hunting, but our K30 system might allow you to legally take your AR with you for hunting.

Pistol Caliber Carbines

K9, K10, K40, K45

Pistol Caliber Carbine Specifications:

- 7075 T6 Aluminum Forged Receivers Made By Olympic Arms
- Black Matte Anodized Receivers, Parkerized Steel Parts
- Blow-back Operated Semi-Automatic Action
- You Choose From Four Pistol Calibers
- Fully Adjustable A2 Rear Sight
- 16" Barrel In 416 Stainless Steel
- Long Life Non-Chromed Bore
- 1x16" Twist Rate
- Threaded Muzzle, Flash Suppressor
- A2 Buttstock
- Barrels Only Available In 16" Lengths

Though not shown in all photos, standard rifles come with bayonet lugs, threaded muzzles, and flash suppressors.



COMPLETE PISTOL CALIBER RIFLE:

\$695⁰⁰
MSRP

COMPLETE PISTOL CALIBER UPPER:

\$495⁰⁰
MSRP

Pistol Caliber Rifles Available

- K9** 9mm Caliber
 - Includes 32 round converted Sten magazine.
 - K10** 10mm Caliber
 - Includes 10 round converted Uzi magazine.
 - K40** 40 S&W Caliber
 - Includes 10 round converted Uzi magazine.
 - K45** 45 ACP Caliber
 - Includes 10 round converted Uzi magazine.
- Extra Magazines \$50⁰⁰*
- Same as included magazines per caliber listed above.

These handy pistol caliber carbines are Olympic Arms originals and are some of the best AR style pistol caliber carbines on the market. Designed with a straight blow-back system and our patented conical shaped bolt and chambering built into an unbelievably reliable rifle. Ammunition feeding and hollow point bullets are not a problem for this rifle. Our design has the mag well block adapter attached to the magazine body, so there is no need for mag well inserts. Everything adds to a positive and reliable rifle.

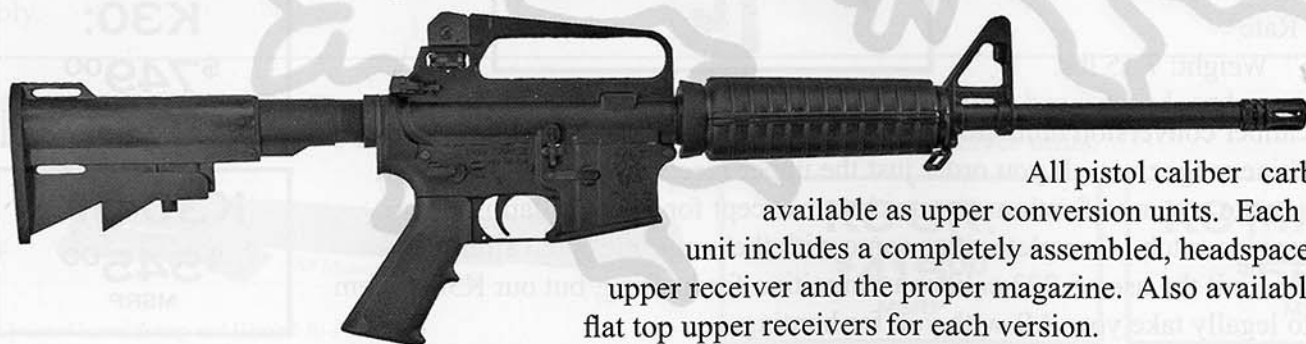

All pistol caliber carbine rifles are available as upper conversion units. Each upper conversion unit includes a completely assembled, headspaced, and test fired upper receiver and the proper magazine. Also available are picatinny flat top upper receivers for each version.

Glock® Lower Pistol Caliber Rifles

K9GL & K40GL

Pistol Caliber Carbine Specifications:

- 7075 T6 Aluminum Forged Receivers Made By Olympic Arms
- Black Matte Anodized Receivers, Parkerized Steel Parts
- Gas Operated Semi-Automatic Action
- Glock® Style Lower Receiver
- Choose Either 9mm Or 40 S&W Calibers
- Fully Adjustable A2 Rear Sight
- Choose Barrel Type In 4140 Chromemoly Steel
- Long Life Non-Chromed Bore
- 1x16" Twist Rate
- Collapsible Stock
- Varying Overall Lengths & Weights

K9GL:
\$770⁰⁰
MSRP

K40GL:
\$770⁰⁰
MSRP

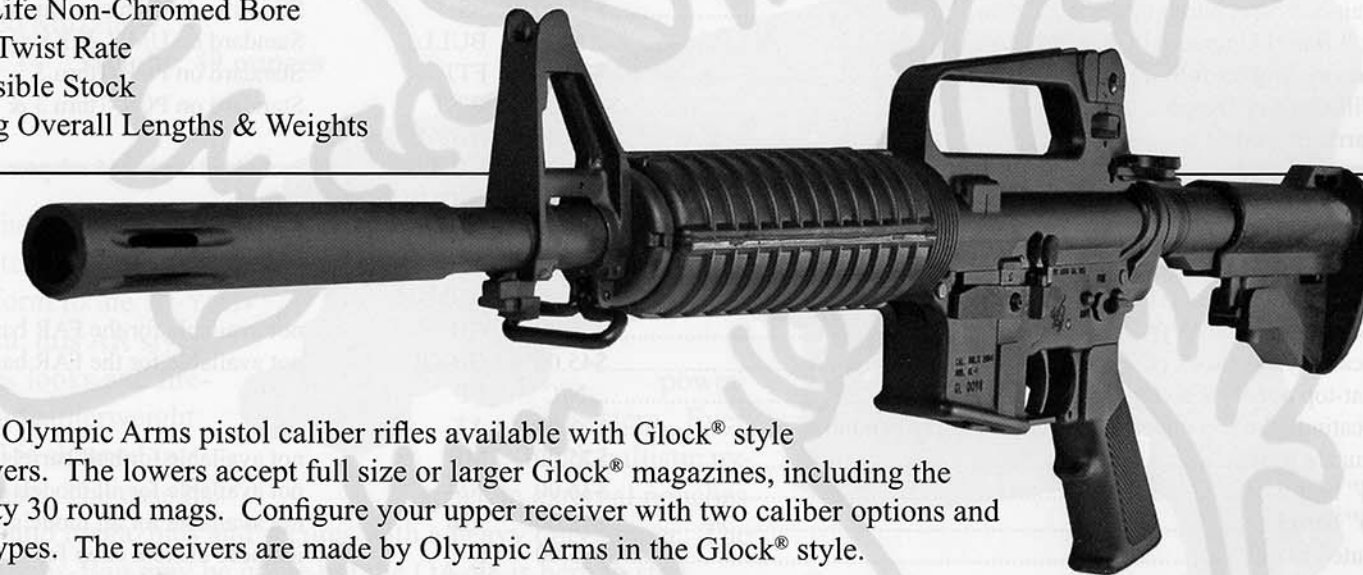

Introducing Olympic Arms pistol caliber rifles available with Glock® style lower receivers. The lowers accept full size or larger Glock® magazines, including the high-capacity 30 round mags. Configure your upper receiver with two caliber options and two barrel types. The receivers are made by Olympic Arms in the Glock® style.

Using a straight blow-back system, the bolt will lock back after the last round is fired. With our patented conical shaped bolt and chambering this rifle stands to be unbelievably reliable. Choose a caliber option of either 9mm or 40 S&W. Then choose the barrel type of either 11.5" with a permanently attached 5.5" flash suppressor or a straight 16" barrel. The lower receiver utilizes a standard magazine release button to release the Glock® magazine. *Please specify caliber and barrel version when ordering.*

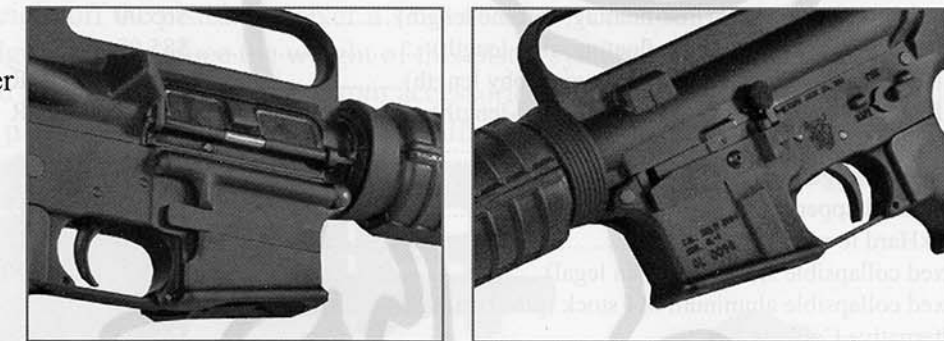

Glock is a registered trademark of Glock, Inc.

Standard Rifle Options Listing

At Olympic Arms we offer more options and variations than any other AR style rifle manufacturer. To simplify ordering and pricing we offer the following consolidated list of available options. Please note that not all options listed will be available for each standard rifle offered. Also, this list does not contain every option available. For example a MIL4 style barrel cannot be fluted, nor are accessories for the FIRSH handguard listed. Shown on this page are the most popular options ordered and their prices in an easy to read form.

To ensure order accuracy and availability please call our Customer Service Team.

Complete Weapon Options:	Price:	Code:	Notes:
Stainless Steel barrel upgrade	\$35.00	SS	SS is standard on some models.
Bull Barrel Upgrade (PCR-3 only)	N/C	BULL	Standard on UM-1 & K8 series.
Factory Trigger Job	\$35.00	FTJ	Standard on PCR-1 thru 3
Williams Set Trigger	\$145.00	WST	Standard on PCR-1 thru 3 & PCR-SM
Harris Bi-Pod	\$65.00	HBP-1	
Harris Bi-Pods	\$80.00	HBP-1-GI	Includes Harris #15 adapter
Harris S-Series Bi-Pods (on free float handguards)	\$72.00	HBP-2	
Harris S-Series Bi-Pods (on GI handguards)	\$87.00	HBP-2-GI	Includes #15 adapter
Bi-pod stud/mount (free float handguard)	\$20.00	BPS	
Bi-pod stud/mount (Harris #5 universal for GI handguards)	\$15.00	HBM-15	
Picatinny gas block (w/free floated handguard)	\$35.00	GB	not available for the FAR barrels
Picatinny gas block (w/standard GI handguards)	\$45.00	GB-GI	not available for the FAR barrels
Flat-top upper receiver; Picatinny style	N/C	FT	
Picatinny flat-top upper w/Detachable Carry handle	\$75.00	A3	
Muzzle Brake	\$25.00	MB	not available for bull barrels or FAR-15.
24" barrel	\$36.00	+24	not available for all models
26" barrel	\$48.00	+26	not available for all models
Fluted barrel	\$125.00	F	includes custom shop fee
Ultramatch barrel upgrade	\$89.00	SUM	standard on some, N/A on other models
Aluminum Free-float handguard (carbine)	\$35.00	F8A	standard aluminum FF-handguard
Aluminum Free-float handguard (rifle)	\$43.00	F7A	standard aluminum FF-handguard
M4 Style handguards	\$15.00	M4S	for carbines only; w/single heat shield
FIRSH Rail handguard (free-floating; carbine length)	\$65.00	F8R	for 16" barrels
FIRSH Rail handguard (free-floating; rifle length)	\$85.00	F7R	for 20" barrels
FIRSH Rail handguard (free-floating; stubby length)	\$45.00	F23R	for 6.5" barrels
FIRSH Rail handguard (free-floating; mid-length)	\$75.00	F85R	for mid-length barrels
Factory Trigger Job	\$35.00	TJ	standard some models
2-Stage Trigger	\$89.00	2ST	standard on PCR-SMP model
MaxHard upper	\$50.00	MXU	A2 or Flat-top (Plinker excluded)
MaxHard lower	\$50.00	MXL	for forged receiver weapons only
Fixed collapsible stock (post-ban legal)	N/C	T30NC	not available for 20"+ barreled rifles
Fixed collapsible aluminum M4 stock (post ban legal)	\$35.00		
Alternative Calibers	\$45.00	AltCal	please ask sales rep for details
Alternate twist rates (depends on model and caliber)	\$43.00	Alt	please ask sales rep for details
Ergo Grip	\$13.00	Ergo	specify left, right, or ambi
Ergo Sure Grip	\$20.00	ErgoSG	right hand only
Ergo Tactical Pistol Grip	\$42.00	TG	Ambidextrous with palm shelf
Ace® FX Stock	\$50.00	FX	standard Ace® FX stock
Ace® FX Stubby stock	\$62.00	FX-Stubby	stubby/entry length Ace® FX stock
Ace® Ultralight stock	\$56.00	FXUL	Ace® Ultralight stock
Ace® Ultralight Stubby stock	\$58.00	FXUL-Stubby	Ace® Ultralight Stubby length stock

Additional options are available as we are taking on new product lines all throughout the year. Make sure you ask our Customer Service Team or your local sales representative for details or updates on current option availability.

OA-98 AR Style Pistol

OA-98:
\$850⁰⁰
MSRP

OA-98 Specifications:

- 7075 T6 Aluminum Forged Receivers Made By Olympic Arms
- Black Matte Anodized Receivers, Parkerized Steel Parts
- Gas Operated Semi-Automatic Action
- 5.56 NATO Caliber
- Picatinny Style Flat Top Upper Receiver
- 6.5" Barrel In 416 Stainless Steel
- Long Life Non-Chromed Bore
- 1x7" Twist Rate
- Crowned Muzzle
- Length: 14" **Weight: 49 ounces**

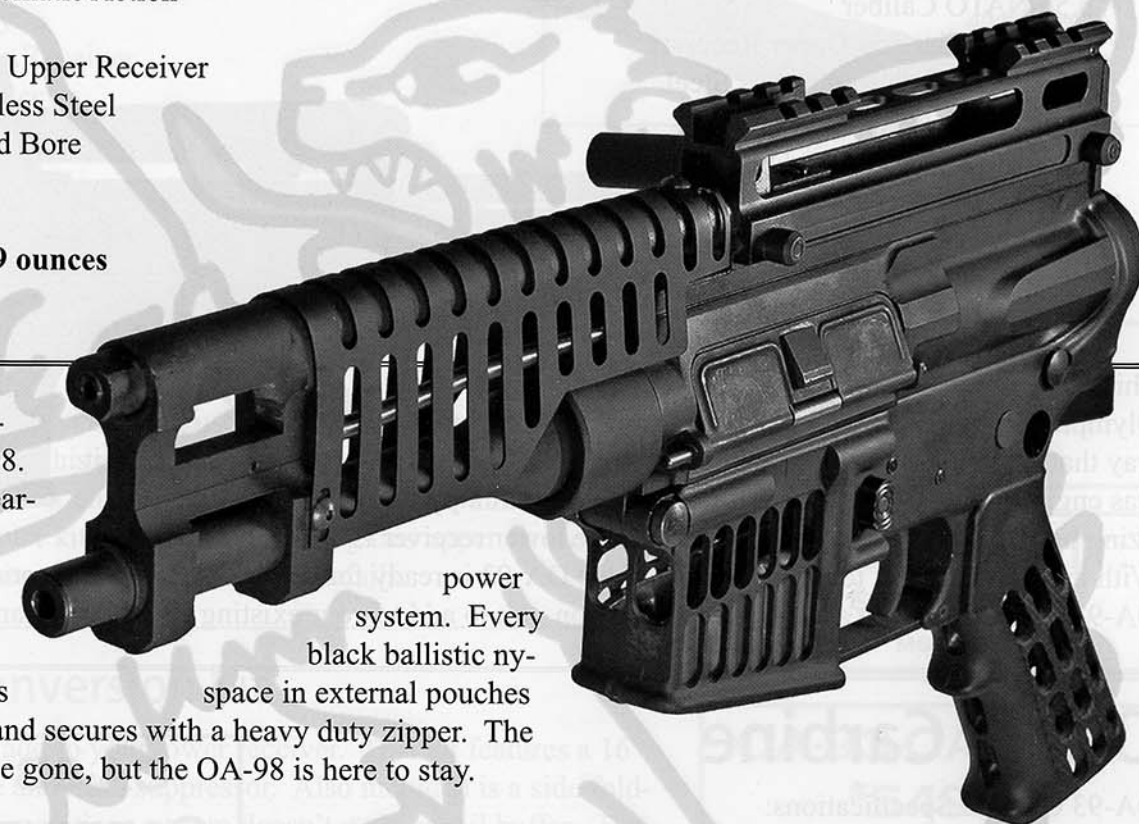

Member of the family of OA-93 pistol systems is the OA-98. Built to conform to the 10-Year-Weapons-Ban, this AR style pistol still has looks and fire-packed into a featherweight system. Every OA-98 pistol is shipped in a black ballistic nylon assault case. The case has space in external pouches for two 30 round magazines and secures with a heavy duty zipper. The 10-Year-Weapons-Ban may be gone, but the OA-98 is here to stay.

The OA-98 operates off of the OA-93 integrated recoil system and allows the elimination of the buttstock. Looking at the OA-98 you can see that we've taken weight off the pistol wherever it's not needed. A custom mesh handguard, a milled magazine well, and a machined handgrip, all to reduce the weight of this pistol system. The upper receiver is topped with an integrated charging handle and picatinny mounts for custom accessories. The photos also show a magazine stub partially inserted to help you visualize how this pistol's magazine well looks when loaded.

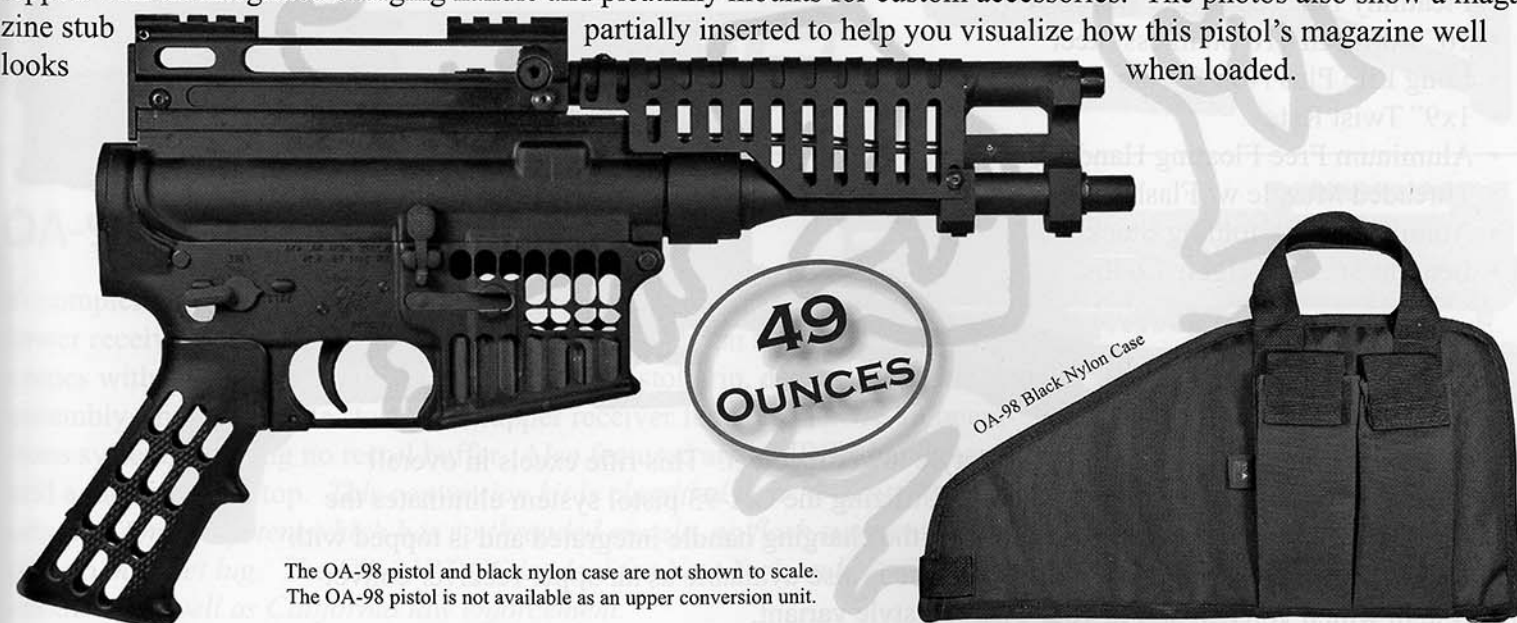

The OA-98 pistol and black nylon case are not shown to scale. The OA-98 pistol is not available as an upper conversion unit.

OA-93

OA-93 Specifications:

- 7075 T6 Aluminum Forged Receivers Made By Olympic Arms
- Black Matte Anodized Receivers, Parkerized Steel Parts
- Gas Operated Semi-Automatic Action
- 5.56 NATO Caliber
- Picatinny Flat Top Upper Receiver
- 6.5" Barrel In 416 Stainless Steel
- Long Life Non-Chromed Bore
- 1x7" Twist Rate
- Aluminum Free Floating Handguard
- Threaded Muzzle w/ Flash Suppressor
- No Buttstock!
- Length: 26.5" Weight: 5.8 lbs.

This is the foundation of the OA-93 family of weapons from Olympic Arms. The OA-93 AR style pistol is manufactured in such a way that no buttstock assembly is needed. This pistol is not a re-style, it was engineered to be the most effective, reliable AR style handgun available. Utilizing basic ideas from the AR style rifles, the lower receiver is of a familiar style. With the picatinny flat top upper receiver, the OA-93 is ready for your choice of CQB optics. The OA-93 is also available as an upper conversion unit to add to your existing AR style variant.

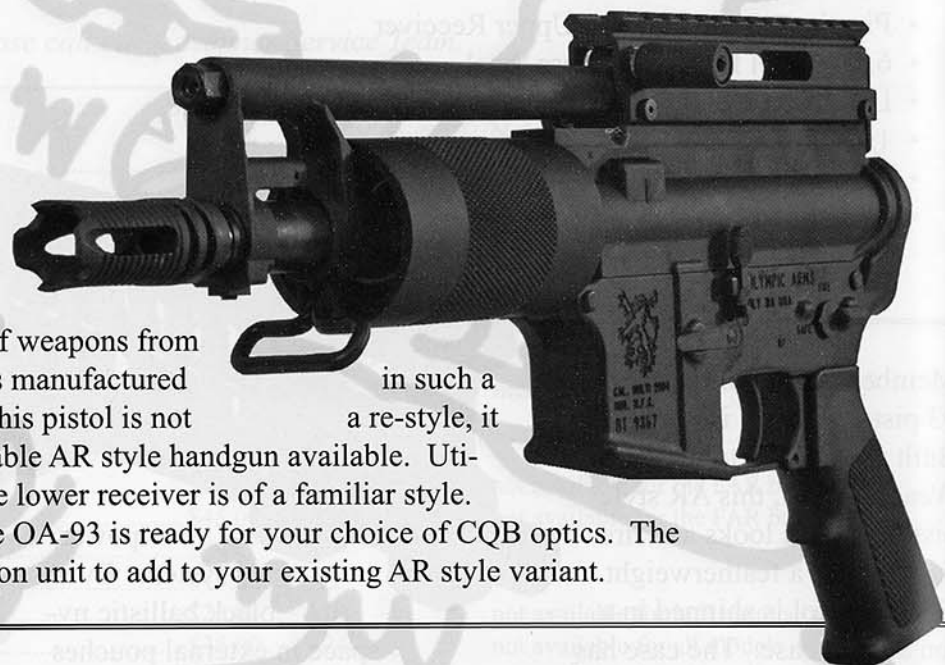

OA-93:
\$850⁰⁰
MSRP

OA-93 Carbine

OA-93 Carbine Specifications:

- 7075 T6 Aluminum Forged Receivers Made By Olympic Arms
- Black Matte Anodized Receivers, Parkerized Steel Parts
- Gas Operated Semi-Automatic Action
- 5.56 NATO Caliber
- Picatinny Flat Top Upper Receiver
- 16" Barrel In 416 Stainless Steel
- Long Life Plus Non-Chromed Bore
- 1x9" Twist Rate
- Aluminum Free Floating Handguard
- Threaded Muzzle w/ Flash Suppressor
- Aluminum Side-folding Stock
- Length: 36.5" Weight: 7.6 lbs.

An AR style carbine rifle with a side-folding stock attached to a standard mil-spec, unmodified, AR style lower receiver. This rifle excels in overall versatility as well as parts interchangeability. Utilizing the OA-93 pistol system eliminates the need for a recoil buffer. The upper receiver has the charging handle integrated and is topped with a picatinny mounting system. The OA-93 carbine is also available as an upper receiver conversion system which you can add to your own AR style variant.

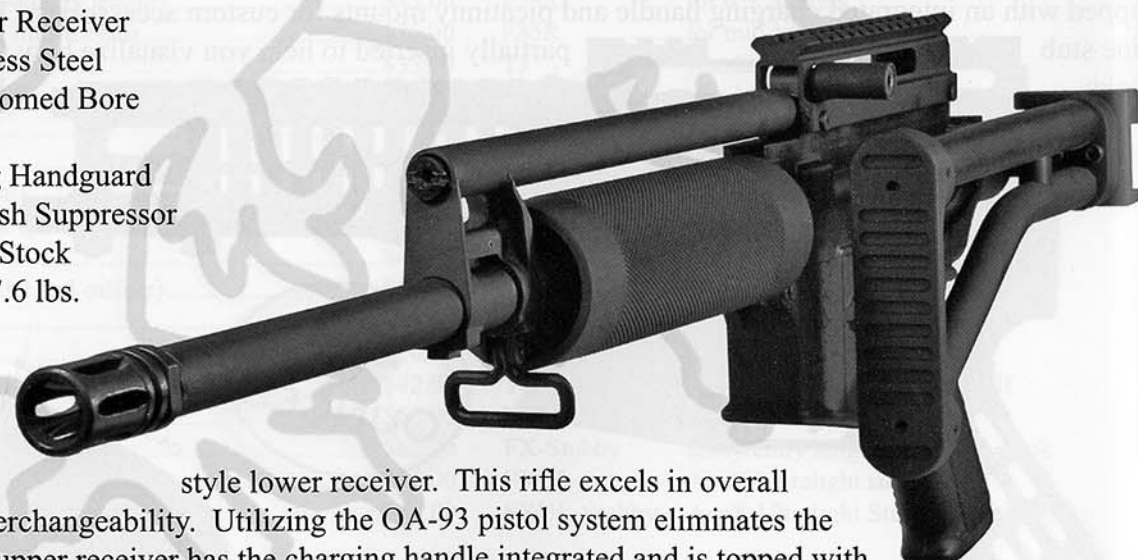

OA-93
CARBINE:
\$895⁰⁰
MSRP

OA-93 Upper Receiver Conversion Kits

OA-93 Carbine Upper Receiver Specifications:

- 7075 T6 Aluminum Forged Receiver Made By Olympic Arms
- Black Matte Anodized Receivers, Parkerized Steel Parts
- Gas Operated Semi-Automatic Action
- 5.56 NATO Caliber Only
- Picatinny Flat Top Upper Receiver
- Barrel In 416 Stainless Steel
- Long Life Plus Non-Chromed Bore
- 1x7" Twist Rate
- Free Floating Handguard
- No Buttstock Needed!



OAS Open Sight Rails. Designed for the OA-93 series of rifles. This sighting system mounts to the flat top OA-93 upper receivers. *5.5" sight radius, made from aluminum.*

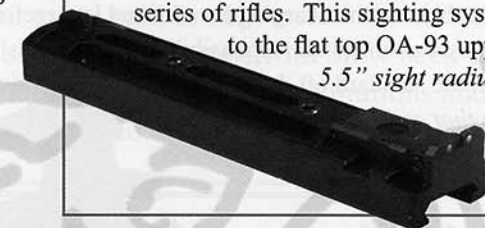

\$89⁰⁰

OA-93 Upper Receiver

The center of the OA operations system and used by military and government agencies around the world. Use this upper receiver to create a true AR style pistol. Complete with 6.5" barrel, tubular aluminum handguard, flat top, threaded muzzle, and flash suppressor. An adapter kit is available for using this upper on older lower receivers. Call our Customer Service Team for details.

OA-93-UR:
\$695⁰⁰
MSRP

OA-93-CAR-KIT:
\$649⁰⁰
MSRP

OA-93 Carbine Conversion Kit

A complete conversion kit to add to your lower receiver. This kit features a 16" barrel with a threaded muzzle and flash suppressor. Also included is a side folding stock because the OA-93 operations system doesn't use a recoil buffer. The handguard is a tubular aluminum free floating handguard with a knurled sure grip in the center.

OA-93-CAR-UR:
\$549⁰⁰
MSRP

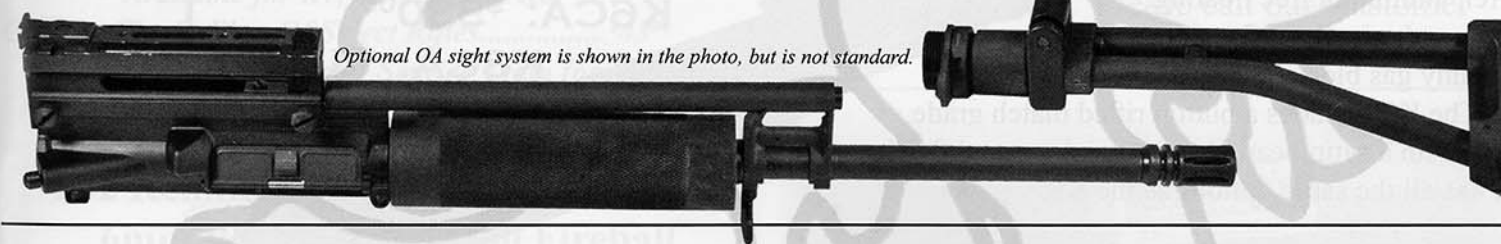

Optional OA sight system is shown in the photo, but is not standard.

OA-93PT Conversion Kit

A complete conversion kit to add to your lower receiver. The OA-93 Packable-Tactical conversion kit comes with a complete upper receiver, vertical pistol grip, detachable stock assembly, and detachable stock. The upper receiver features the OA-93 operations system requiring no recoil buffer. Also featured are a FIRSH handguard and a picatinny flat top. *This conversion kit is classified as a 10-Year-Weapons-Ban format system which has no threaded muzzle, no flash suppressor, and no bayonet lug. The OA-93PT-CK is ideal for New York and New Jersey residents as well as California law enforcement.*



OA-93PT-CK:
\$749⁰⁰
MSRP

Upper Receiver Units

Olympic Arms upper receiver units are available as complete kits or as stripped units. A complete upper receiver kit comes completely assembled with bolt carrier assembly and charging handle, is headspaced, and factory test fired. A stripped upper receiver unit does not include the bolt carrier assembly nor the charging handle, and is therefore not headspaced or test fired. When ordering stripped upper units it is understood that the purchaser assumes all responsibility with regards to proper headspace and function. Both versions of upper units, complete or stripped, come with the standard 60-day satisfaction guarantee and a lifetime warranty. *Whether or not it is shown in the photos, all upper receivers that come with A2 style front post sights have bayonet lugs. The 'S' designation signifies the receiver is stripped, and the 'C' designation signifies the receiver is complete. For example 'K1SA' is the stripped K1 Assembly.*

K1 Carbine 16" Upper Receiver

Comes standard with a heavy match grade contour button rifled barrel in 4140 Chromemoly Steel.



K1SA: \$294⁰⁰
K1CA: \$363⁰⁰

K2 Heavy 20" Match Upper Receiver

Comes standard with a heavy match grade contour button rifled barrel in 4140 Chromemoly Steel.



K2SA: \$320⁰⁰
K2CA: \$394⁰⁰

K6 or K8 Target Match Upper Receivers

Comes standard with a 20" Ultramatch barrel, aluminum free floating handguard, picatinny flat top upper, picatinny gas block, and a crowned muzzle. The K8 includes a button rifled match grade barrel with a satin bead blasted stainless steel finish and has all the same options as the K6.



K6CA: \$530⁰⁰
K8CA: \$415⁰⁰

Configuration Options:

K1 K2 K6	Code	Description	Cost	K1 K2 K6	Code	Description	Cost
	• 24	24" Barrel.....	\$36 ⁰⁰		• F8R	Carbine Length FIRSH	\$65 ⁰⁰
	• 26	26" Barrel.....	\$48 ⁰⁰	• • •	F	Fluted Barrel	\$124 ⁰⁰
	• B	Harris Bi-pod Installed.....	\$65 ⁰⁰	•	FAR	Featherweight Barrel.....	\$35 ⁰⁰
	• B2	Harris S-Series Bi-pod Installed	\$72 ⁰⁰	• •	FT	Flat Top Upper Receiver	No Charge
• •	A3	FT w/ Detachable Carry Handle ...	\$79 ⁰⁰	•	M4S	MIL4 Style Handguards.....	\$18 ⁰⁰
• •	ALT	Specified Alternate Twist Rate	\$43 ⁰⁰	•	MIL4	MIL4 16" Contoured Barrel.....	\$35 ⁰⁰
•	CAR	Carbine 11.5" Barrel	\$20 ⁰⁰	• •	SS	Stainless Steel Barrel	\$35 ⁰⁰
•	ELIM	Eliminator Barrel	\$43 ⁰⁰	•	ST	Bi-pod Stud Installed	\$20 ⁰⁰
• •	F7R	Full Length FIRSH	\$85 ⁰⁰	• •	U	Unassembled.....	-\$35 ⁰⁰

Pistol & Rifle Caliber Conversion Kits

These are the original pistol caliber conversion kits. Mate your standard mil-spec AR style lower receiver with one of our upper receiver conversion kits to fire pistol caliber or alternate rifle caliber cartridges. We patented the forcing cone chambers and designed the unique spring ejector system to make our pistol caliber conversion kits exceedingly reliable and accurate. Kits are upper receiver units with 16" stainless steel button rifled barrels with blow back operation are completely assembled, headspaced, and factory test fired. Calibers are limited among configurations and availability. Please check with our customer service team to have your questions answered.

Pistol Calibers Available

Upper Receiver Unit..... \$495⁰⁰ each

• Please specify one of the pistol calibers listed below.

- K9-UR 9mm Caliber
 - Includes 32 round converted Sten magazine.
- K10-UR 10mm Caliber
 - Includes 10 round converted Uzi magazine.
- K40-UR 40 S&W Caliber
 - Includes 10 round converted Uzi magazine.
- K45-UR 45 ACP Caliber
 - Includes 10 round converted Uzi magazine.

Extra Magazines \$50⁰⁰

• Same as included magazines per caliber listed above.



Configuration Options:

Code	Description	Cost
A3	FT w/ Detachable Carry Handle.....	\$75 ⁰⁰
CAR	Carbine 11.5" Barrel.....	\$20 ⁰⁰
F8R	Carbine Length FIRSH.....	\$65 ⁰⁰
FT	Flat Top Upper Receiver	No Charge

All pistol caliber conversion kits are available in Class III configurations as well. As always a copy of your weapons Form 4 or a copy of your company's valid SOT is required for every Class III transaction.

Rifle Calibers Available

Change The Caliber Of An Upper Unit \$43⁰⁰

• Available for K1, K2, K6, and K8.

Change The Caliber Of Select Rifles..... \$43⁰⁰

• Call our Customer Service Team for details.

- 17 Remington 6 x 45
- 222 Remington 7.62 x 39mm
- 6mm PPC 300 Fireball

Alternate pistol and rifle calibers can be ordered with select upper receiver units as well as select complete rifles. Please call our Customer Service Team for details.

The prices shown are in addition to the base price of the order. For example add the price shown above to the price of a K2CA to get the price for a 20" upper receiver with your specified alternate caliber.

Magazines may not be available for some calibers, call our Customer Service Team for details.

Still offering more caliber options than any other manufacturer anywhere, we are still making uppers in alternative calibers every year. Recently added to the Olympic Arms list of options is the popular 300 Fireball. A true 30 caliber round based on the 221 Fireball casing which is a great choice for subsonic use or varminting.



Pistol Caliber Conversion Parts

The parts listed on this page are Olympic Arms proprietary components for Olympic Arms pistol caliber AR style products only. None of the below parts are interchangeable with other manufacturer's pistol caliber components.

PC24 Pistol Caliber Bolt Carrier Assembly

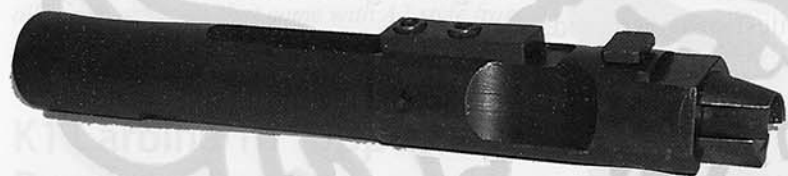

A complete bolt carrier assembly for our popular pistol caliber AR style units. Available for 9mm, 10mm, 40 S&W, and 45 ACP. It is important to specify the caliber when ordering.

Also available for full auto, please call for details.

PC24:
\$110⁰⁰
MSRP

PC26 Pistol Caliber Bolt Assembly



The Olympic Arms patented conical bolt assembly used in our own pistol caliber conversion systems. Comes complete with extractor. Available for 9mm, 10mm, 40 S&W, and 45 ACP. Please specify the caliber when ordering.

PC26:
\$65⁰⁰
MSRP

ESEJP ESpring® Pistol Caliber Ejection Spring



A popular replacement part for pistol caliber conversion systems, this new ejector spring will not bend or become weak with age. Made from an alloy specifically engineered to work under pistol caliber conditions, this is a proprietary part that Olympic Arms pistol caliber systems requires. A great part to have as a spare in the tool kit.

ESEJP:
\$4⁰⁰
EACH

PC28 Ejector Spring Assembly

A complete replacement set of the pistol caliber ejector spring assembly. Includes one each ejector; spring, retainer, retainer pin, and positioning pin.



PC28:
\$10⁰⁰
MSRP

PC39B Firing Pin Spring



Required for blow-back pistol caliber operations systems, this spring prevents inertia firing from occurring.

PC39B:
\$1⁰⁰
EACH

PC36 Extractor



Machined extractor for pistol caliber conversions available for 9mm, 10mm, 40 S&W, and 45 ACP. Please specify the caliber when ordering.

PC36:
\$18⁰⁰
MSRP

PC38 Extractor Spring



A proprietary extractor spring for pistol caliber bolt assemblies. Not the same for 5.56 or .223 bolt assemblies.

PC38:
\$1⁰⁰
EACH

22+17 Solution Rifle Conversion Kit

At Olympic Arms we keep a watch on what our customers need. Over time we have seen the need for live fire training but at a lower cost. In response we now have a conversion system that allows the shooter to use .22 LR or .17 MK2 caliber ammunition in an AR style rifle.

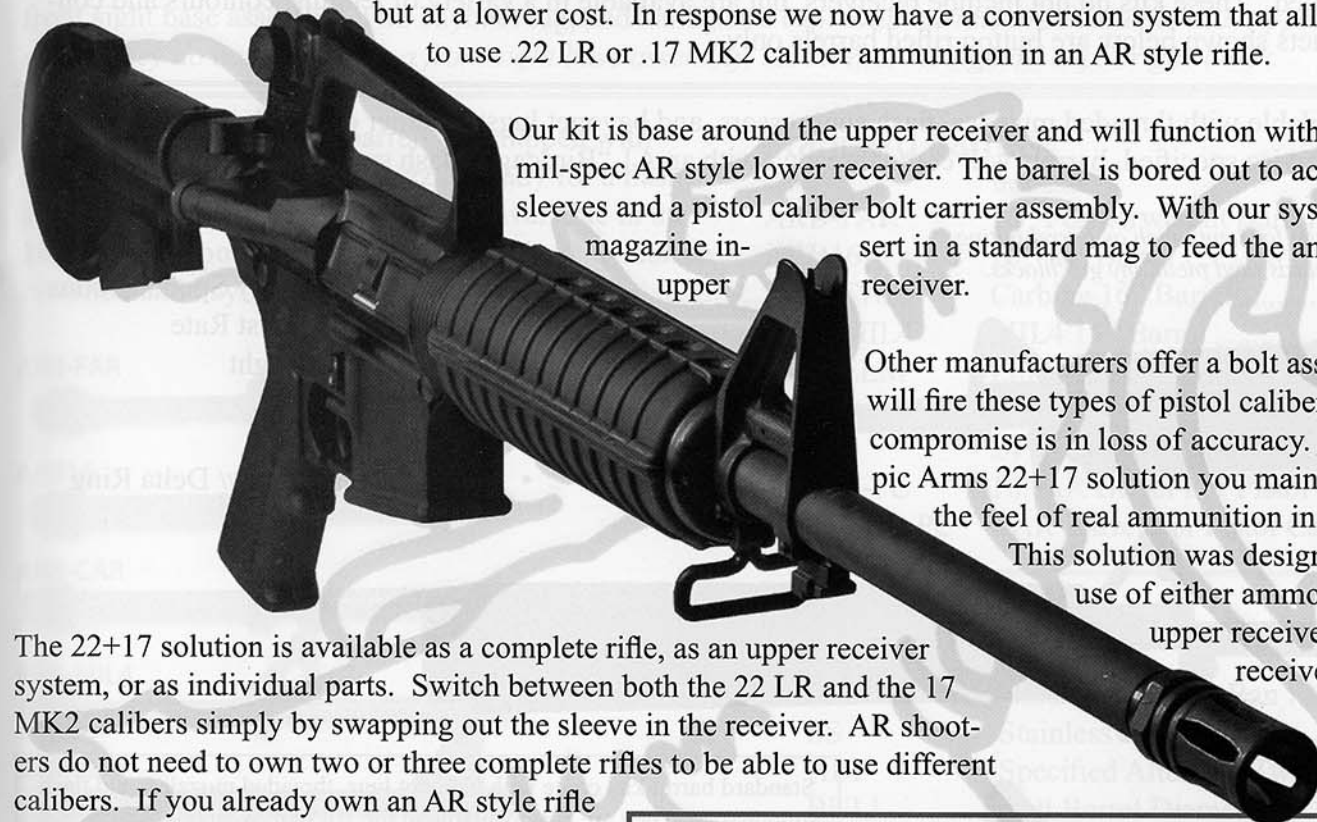

Our kit is base around the upper receiver and will function with any standard mil-spec AR style lower receiver. The barrel is bored out to accept calibrated sleeves and a pistol caliber bolt carrier assembly. With our system you use a magazine insert in a standard mag to feed the ammunition to the receiver.

Other manufacturers offer a bolt assembly which will fire these types of pistol caliber ammo, but the compromise is in loss of accuracy. With the Olympic Arms 22+17 solution you maintain accuracy and the feel of real ammunition in an AR style rifle. This solution was designed to allow the use of either ammo from the same upper receiver and lower receiver.

The 22+17 solution is available as a complete rifle, as an upper receiver system, or as individual parts. Switch between both the 22 LR and the 17 MK2 calibers simply by swapping out the sleeve in the receiver. AR shooters do not need to own two or three complete rifles to be able to use different calibers. If you already own an AR style rifle you have the option of our upper receiver solution with either or both pistol calibers to use with your current lower.

The sleeves can only be used with our 22+17 barrel and the bolt carrier assembly we provide, otherwise we cannot guarantee safety, reliability, or accuracy. Complete rifles and upper receivers include a magazine with a magazine insert.

22SR	Complete Rifle With 22LR Sleeve.....	\$630 ⁰⁰
17SR	Complete Rifle With 17MK2 Sleeve	\$630 ⁰⁰
2217SR	Complete Rifle With Both Caliber Sleeves.....	\$697 ⁰⁰
22SU	Upper Receiver With 22LR Sleeve.....	\$369 ⁰⁰
17SU	Upper Receiver With 17MK2 Sleeve	\$369 ⁰⁰
2217SU	Upper Receiver With Both Caliber Sleeves.....	\$429 ⁰⁰
22S	Sleeve 22LR As Separate Component.....	\$89 ⁰⁰
17S	Sleeve 17MK2 As Separate Component.....	\$89 ⁰⁰
MI	Magazine Insert: Will Be Available At Later Date	

Call our Customer Service Team for details on the 22+17 Rifle Solution.



Targets shot with .22 LR ammunition by Steve Houseman at the Olympic Arms underground shooting range. Three targets of five shots each grouped under .780 from 100 yards.

Barrel Kits

A complete barrel kit is exactly what a tired out AR needs. Also great for reconfiguring. All parts are for a complete re-barrel are included. These kits do not include receivers, but are available in a variety of lengths, contours and configurations. Products shown below are button rifled barrels only.

All barrel kits available with threaded muzzles, flash suppressors, and bayonet lugs; whether or not shown photographically. Unless otherwise specified, barrels will come threaded with an A1 "Birdcage" flash suppressor.

See the options page for items such as barrel fluting, FIRSH handguards, and picatinny gas blocks.

Standard Barrel Assembly Specifications:

- Barrel w/ 1x9" Twist Rate
- Complete Front Sight
- Barrel Nut
- Gas Tube Assembly
- Plastic Handguards w/ Delta Ring



Standard barrel kits come with bayonet lugs, threaded muzzles, and flash suppressors. They are also available in the 10-Year-Weapons-Ban format which has the bayonet lug removed and the muzzle crowned.

Standard Configurations:

Code	Description	Cost
F1A	16" In 4140 Chromemoly Steel.....	\$149 ⁰⁰
F1B	16" In 416 Stainless Steel.....	\$184 ⁰⁰
F1C	CAR In 4140 Chromemoly Steel.....	\$199 ⁰⁰
F1D	CAR In 416 Stainless Steel.....	\$234 ⁰⁰
F1E	20" In 4140 Chromemoly Steel.....	\$164 ⁰⁰
F1F	20" In 416 Stainless Steel.....	\$199 ⁰⁰
F1G	FAR-15 Lightweight.....	\$195 ⁰⁰
F1H	16" MIL4 In Stainless Steel.....	\$195 ⁰⁰
F1HB	F1H w/ MIL4S Handguards.....	\$285 ⁰⁰
F1J	Eliminator In 4140 Chromemoly Steel.....	\$199 ⁰⁰
F1K	Eliminator In 416 Stainless Steel.....	\$234 ⁰⁰

Optional heat shields for 16" kits with handguards are available for an additional \$5⁰⁰. Contact our Customer Service Team for details on options.

K23B "Stubby" Barrel Assembly Shown

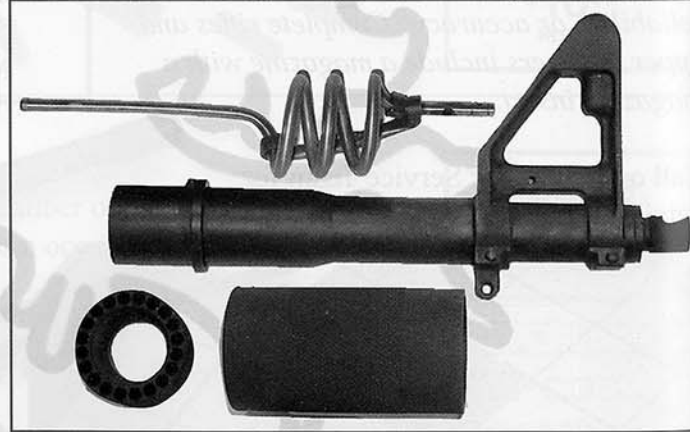

F1-23 K23B Barrel Assembly

This kit comes with a 6.5" button rifled barrel, "Stubby" aluminum free floating handguard, and the "Pig-Tail" gas tube.

F1-23:
\$179⁰⁰
MSRP

AR Style Buttoned Barrels

These barrels are new production AR style barrels made from 4140 Chromemoly Steel and are precision button rifled with six lands and grooves and a standard 1x9" twist rate. Each barrel comes complete with a new barrel nut, entire front sight base assembly with bayonet lug, and handguard cap. *Bull barrels are available as stripped only, which means they do not come with a front sight base assembly, barrel nut, handguard cap, or gas block.*

As standard, all non-bull barrels are shipped with bayonet lugs and threaded muzzles ready for a flash suppressor. However, all barrels are available in the **10-Year-Weapons-Ban format** which has the muzzle crowned and bayonet lug removed.

Standard Barrels:

Code	Description	Cost
ARB-FAR	16" Featherweight Barrel.....	\$161 ⁰⁰
ARB16	16" AR Barrel.....	\$126 ⁰⁰
ARB-CAR	Carbine 16" Barrel.....	\$140 ⁰⁰
ARB-MIL4	MIL4 16" Barrel.....	\$161 ⁰⁰
ARB-ELM	Eliminator 16" Barrel.....	\$161 ⁰⁰
ARB20	20" AR Barrel.....	\$161 ⁰⁰
ARB24	24" AR Barrel.....	\$181 ⁰⁰
ARB16-PC	16" AR Barrel For Pistol Calibers...	\$159 ⁰⁰
ARB-CAR-PC	CAR Barrel For Pistol Calibers.....	\$181 ⁰⁰

ARB-FAR

ARB16

ARB-CAR

ARB-MIL4

ARB-ELM

ARB20

ARB24

ARB16-BULL

ARB20-BULL

ARB24-BULL

ARB20 Fluted

ARB24 Fluted

Shown with satin bead-blast finish.

Barrel Options:

Code	Description	Cost
AWB	Assault Weapons Ban Format.....	No Charge
SS	Stainless Steel ¹	\$35 ⁰⁰
ALT	Specified Alternate Twist ²	\$45 ⁰⁰
BULL	Bull Barrel Diameter.....	No Charge
—	Custom Shop Fee ³	\$50 ⁰⁰
F	Fluted Barrel.....	\$75 ⁰⁰
—	Custom Length, Contour, Thread... ⁴	\$35 ⁰⁰

Alternate Calibers Available⁴:

5.56 NATO ⁵	7.62x39
6PPC	.300 Fireball
6x45	.17 Remington

Prices vary for alternate caliber barrels, please call our Customer Service Team for details and limitations.

About Barrel Fluting

Fluted AR barrels are available in both the button rifled and broach cut (Stainless Ultramatch) styles.

All barrels are fluted with six grooves 1/4" wide each. This end-mill cut method increases surface area by 105% which increases cooling during periods of rapid fire. The fluting process not only reduces barrel weight by 12 to 14 ounces, it also increases rigidity by 20 to 25 percent.

⁽¹⁾ Does not apply to MIL4 or Eliminator barrels because they are stainless steel only. ⁽²⁾ Alternate twists are available for the 5.56 NATO chambering only and are only available in 1x7, 1x12, and 1x14 as subject to availability. ⁽³⁾ Any barrel ordered with custom shop options (Fluting, Custom Length, Contour, Thread) is subject to the Custom Shop Fee plus option fees. ⁽⁴⁾ Alternate calibers are not available in all configurations and are subject to availability. ⁽⁵⁾ The 5.56 NATO chambering is the default caliber for barrels.

AR Style Ultramatch Barrels

The Olympic Arms series of Ultramatch and Stainless Ultramatch (SUM) barrels are new production AR style barrels made from 416 Stainless Steel bar stock and broach cut to the GI specified National Match four lands and four grooves bore. Each barrel blank is double heat stress relieved and then air-gauged for consistency. Customers continue to let us know that our SUM barrels are the best AR barrels they have used. *Unless otherwise specified, all SUM barrels are delivered with a 1x10" twist rate and a black oxide coating.*

As standard, all non-bull barrels are shipped with bayonet lugs and threaded muzzles ready for a flash suppressor. However, all barrels are available in the **10-Year-Weapons-Ban format** which has the muzzle crowned and bayonet lug removed.



Standard Barrels:

Code	Description	Cost
SUM16	16" Ultramatch Barrel.....	\$191 ⁰⁰
SUM20	20" Ultramatch Barrel.....	\$199 ⁰⁰
SUM24	24" Ultramatch Barrel.....	\$227 ⁰⁰
SUM26	26" Ultramatch Barrel.....	\$257 ⁰⁰

Barrel Options:

Code	Description	Cost
AWB	Assault Weapons Ban Format.....	No Charge
1X8	Substitute 1x8" Twist Rate.....	No Charge
—	Custom Shop Fee ¹	\$50 ⁰⁰
F	Fluted Barrel.....	\$75 ⁰⁰

Read a testimonial to the Ultramatch barrels from one of our 10+ years Olympic Arms distributors, located on the Testimonial Page in the back of the catalog.

(*) Any barrel ordered with custom shop options (Fluting, Custom Length, Contour, Thread) is subject to the Custom Shop Fee plus option fees.

Picatinny Rail Gas Blocks



A great addition to both standard and bull barrels, these gas blocks are machined from solid aluminum extrusion. Cut with standard picatinny rails, they will accept all picatinny standard hardware including detachable A-Frame style front sight bases and globe sights. *Please specify the diameter when ordering; (.728") Standard or (.928") Bull diameters.*

GB:
\$35⁰⁰
MSRP

PCR Rifle And Carbine Kits

Finish out that stripped lower receiver with our carbine and rifle kits. Complete with a fully assembled, headspaced, and factory test fired A2 upper receiver unit, bolt carrier assembly, charging handle, A2 buttstock assembly, pistol grip assembly, and an all new complete lower receiver parts set. The lower receiver parts set includes a hammer, trigger, selector, springs, detents, etc. *To order please choose a base package then an upgrade package if desired and finally add on any individual options you would like. If you have questions about options please contact our Customer Service Team. All non-bull barrels are standard with threaded muzzles, and A2 front sights are standard with bayonet lugs.*



COMPLETE CARBINE KITS
STARTING AT: \$410⁰⁰
(PCR-CK) MSRP

COMPLETE RIFLE KITS
STARTING AT: \$435⁰⁰
(PCR-RK) MSRP

Carbine Kit Upgrade Packages:

MIL4P: MIL4 Carbine PackageAdd \$124⁰⁰
Includes a MIL4 barrel, picatinny flat top upper receiver, detachable carry handle, and MIL4 style handguards.

MIL4TP: MIL4 Tactical PackageAdd \$259⁰⁰
Includes a MIL4 barrel, picatinny flat top upper receiver, detachable carry handle, full length FIRSH handguard, vertical pistol grip, and up to twelve panel covers of your choice from our stock.

VCP: Varmint Carbine PackageAdd \$90⁰⁰
Includes a 16" bull barrel in 4140 Stainless Steel with a 1x9" twist rate and a black oxide coating. Also includes, picatinny flat top upper receiver, picatinny gas block, aluminum free floating handguard, and Ergo® brand pistol grip.

Rifle Kit Upgrade Packages:

TCSP: Tactical Counter Sniper PackageAdd \$499⁰⁰
Includes a 20" stainless steel bull barrel, picatinny flat top upper receiver, picatinny gas block, FIRSH rail handguard, SR1 scope rings, bi-pod mount, Harris S-Series® Bi-Pod, Ergo® brand tactical pistol grip, and a two-stage trigger assembly.

VRP: Varmint Rifle PackageAdd \$105⁰⁰
Includes a 20" stainless steel bull barrel, picatinny flat top upper receiver, picatinny gas block, aluminum free floating handguard, and Ergo® brand pistol grip.

UVRP: Ultra-Varmint Rifle PackageAdd \$279⁰⁰
Includes a 20" stainless steel bull barrel, picatinny flat top upper receiver, picatinny gas block, aluminum free floating handguard, bi-pod stud, SR1 scope rings, Harris® Bi-Pod, Ergo® brand tactical pistol grip.

Individual Options:

16" MIL4 Stainless Steel Contour Barrel.....	\$50 ⁰⁰
16" Eliminator Barrel.....	\$50 ⁰⁰
Featherweight Barrel.....	\$33 ⁰⁰
Barrel Upgrade To 416 Stainless Steel.....	\$25 ⁰⁰
Fiberite Collapsible Buttstock.....	\$43 ⁰⁰
Satin Stainless Finish For SS Barrels.....	\$10 ⁰⁰
Aluminum Free Floating Handguard.....	\$35 ⁰⁰

Carbine Length FIRSH Handguard.....	\$65 ⁰⁰
Detachable Carry Handle For Flat Top Uppers....	\$79 ⁰⁰
AC4 Pneumatic Recoil Buffer.....	Please Call
Picatinny Gas Block (With Free Floating Handguards) ..	\$42 ⁰⁰
Flash Suppressor.....	Please Call
Assault Weapons Ban Format.....	No Charge

More options are available, please see the Standard Options Listing.

Disclaimer: Olympic Arms cannot be held responsible for the fit, feed, and/or function of any firearm(s) not fully assembled at our factory. As with any mechanical device, some fitting may be required. For your safety, if you are not an experienced gunsmith please do not attempt to assemble any firearm without professional assistance. If you require some technical assistance, please call our Customer Service Team at (800) 228 - 3471.

AR Upper Receivers And Lower Receivers

Olympic Arms has been producing both upper receivers and lower receivers since 1975 and has a history of supplying them to many other brand name manufacturers. No other company will offer you the quality and variety of receivers that Olympic Arms does. From standard 7075 T6 aluminum forged receivers, to the world's only all Titanium lower receivers. *Unless otherwise specified, all receivers come completely stripped.*

K5A97



- T2 Forged A2 Upper Receiver.....\$77⁰⁰
- T12 Forged Picatinny Flat Top Upper Receiver.....\$89⁰⁰
- T2MX Maxhard Forged A2 Upper Receiver.....\$139⁰⁰
- T12MX Maxhard Picatinny Flat Top Upper Receiver.....\$139⁰⁰

K5A



- K5A Assembled lower receiver unit with A2 buttstock, pistol grip, and T3 lower receiver.....\$224⁰⁰
- K5U Unassembled lower receiver unit with A2 buttstock, pistol grip, and T3 lower receiver.....\$199⁰⁰
- K5A97 Assembled lower receiver unit with collapsible stock, pistol grip, and T3 lower receiver.....\$224⁰⁰
- K5U97 Unassembled lower receiver unit with collapsible stock, pistol grip, and T3 lower receiver.....\$199⁰⁰

T3Ti The worlds only all Titanium lower receiver. Ten times stronger than steel but weighs half as much!

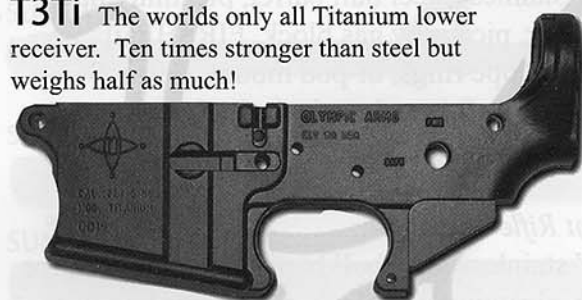

T3 Mil-spec forged receiver, CNC machined at the Olympic Arms manufacturing facility.



T3MX Our proprietary chemical heat-bath process hardens this forged receiver to an RC of 20+! Excellent for match and hi-power rifles.

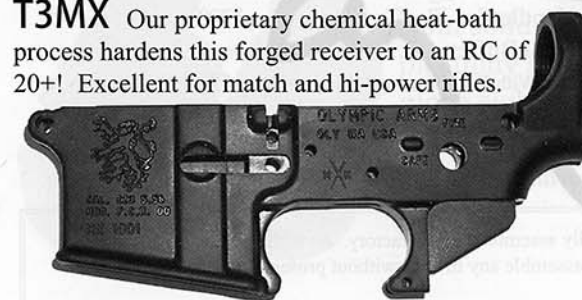

T12



T2



- T3 Forged A2 Lower Receiver.....\$89⁰⁰
- T3Ti Titanium Lower Receiver.....Please Call
- T3MX Maxhard Forged A2 Lower Receiver.....\$139⁰⁰
- T5 Matched set of a T2 upper receiver and a T3 lower receiver.....\$165⁰⁰
- T5MX Matched set of a T2MX upper receiver and a T3MX lower receiver.....\$260⁰⁰
- T6 Matched set of a T3 lower receiver and a T12 upper receiver.....\$177⁰⁰
- T6MX Matched set of a T3MX lower receiver and a T12MX upper receiver.....\$260⁰⁰

AR Parts

T11 Upper Receiver Unit. Includes an A2 upper, E-2 rear sight assembly, ejection cover assembly, and forward assist assembly.



\$138⁰⁰

ASSEMBLED - ADD \$20⁰⁰

T12A Flat Top Upper Receiver Assembly. Includes forward assist assembly and ejection cover assembly.

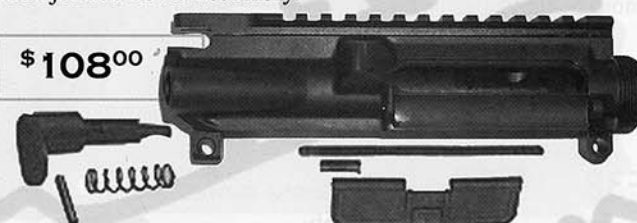

\$108⁰⁰

F11 Detachable A2 Carry Handle. Includes rear sight assembly.



\$79⁰⁰

T13 Scope Mount Base. This is a *see through* mount for A2 uppers. Inexpensive and functional, easy to install.

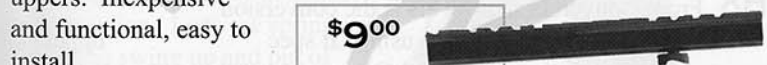

\$9⁰⁰

2ST Two Stage Trigger. A fine two stage trigger machined from carbon steel. For use in any mil-spec lower receiver.



SEPARATE - \$99⁰⁰

RIFLE UPGRADE - \$89⁰⁰

T23 Charging Handle. Machined from 7075 T6 aluminum forging to military specifications. Assembled with latch and roll pin.



\$20⁰⁰

T23TL Charging Handle Tactical Latch. Made from aluminum, makes finding the charging handle quick and easy.

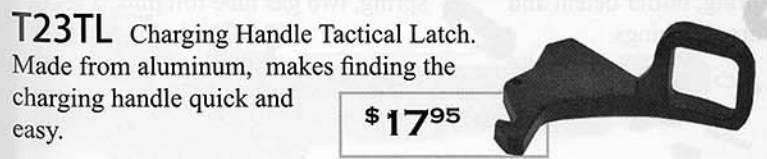

\$17⁹⁵

T14 E-1 Rear Sight Assembly. Includes all new rear sight aperture, adjustable screw, detent and spring, leaf spring, windage drum and roll pin.

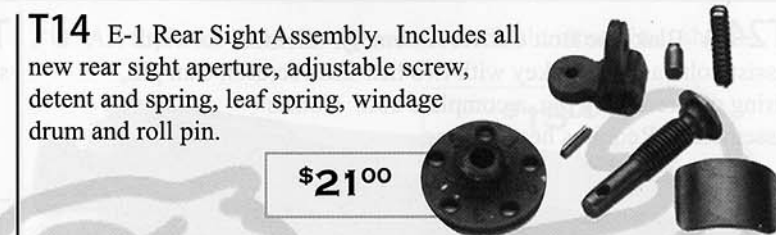

\$21⁰⁰

T15 E-2 Rear Sight Assembly. Includes all new parts for a single installation.



\$50⁰⁰

T15A National Match E-2 Rear Sight System - \$75⁰⁰

BJS National Match Interchangeable Aperture Sights.



\$50⁰⁰

Detachable Sight Systems Olympic Arms quality detachable sights. Manual flip-up operations and made from billet aluminum and steel. All manufactured in the USA.

MASS \$155⁰⁰ Detachable set, front and rear.

MARS \$115⁰⁰ Detachable multiple aperture rear sight.



DFS \$45⁰⁰ Detachable front sight.

T22 Ejection Cover Assembly. Includes new cover, spring, hinge pin, hinge pin clip.

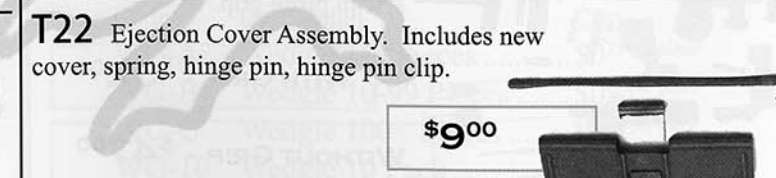

\$9⁰⁰

AR Parts

T24A Blak-Tac Bolt Carrier Assembly. Includes forward assist bolt carrier, gas key with two hex-head screws, cam pin, firing pin, retaining pin, a complete bolt. Comes assembled. Requires headspacing.

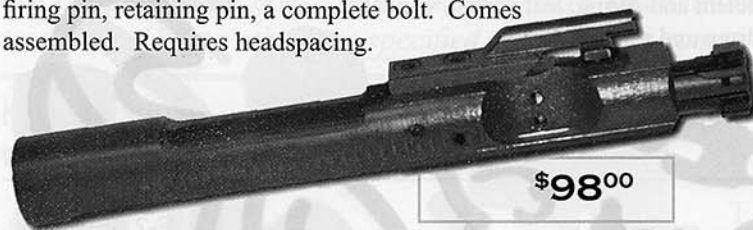

\$98⁰⁰

Flash Suppressors For standard thread muzzles. Will fit all standard threaded Olympic Arms barrels.



F2A Birdcage. Choose A1 or A2.

\$4⁵⁰



F2B Vortex. One of the best, and is supplied to the

\$44⁰⁰



F2C Phantom.

Just as effective as the vortex, but stronger and no open-ended prongs.

\$32⁰⁰



F2MB Olympic Arms own 10-Year-Weapons-Ban muzzle brake. Made specifically for PCR rifles and attaches using four set screws.



\$25⁰⁰

T27 Lower Receiver Parts Set. Includes all the parts necessary to complete a stripped lower receiver. Does not include a buttstock. Available with pistol grip.

WITH GRIP - \$52⁰⁰

WITHOUT GRIP - \$47⁰⁰

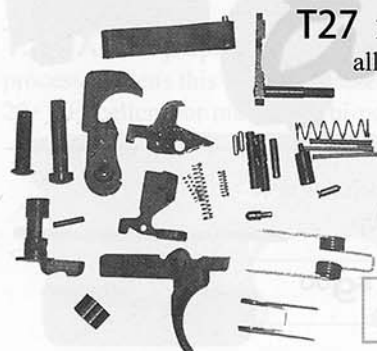

T21 Round Forward Assist Assembly. Complete with springs and pins.

\$13⁰⁰



T26 Complete Bolt. Chrome bolt not available as a separate component. Manufactured to mil-spec.

\$43⁰⁰



Pistol Grip Assembly Includes a new pistol grip, set screw, and a washer. Choose from the three styles listed. See the Ergo® brand accessories page for more pistol grips.

F3A **\$8⁰⁰** A2 style stowaway grip assembly.

F3B **\$7⁰⁰** A2 style non-stowaway grip assembly.

F3E **\$15⁰⁰** Ergo® brand ergonomic pistol grip.



H8 Front Conversion Pin. This is the conversion pin needed when using GI spec upper receivers with Colt® manufactured lower receivers.

\$6⁰⁰



H15 Anti-Walk Pins. Often used on full automatic rifles, but also great for older or worn out lower receivers. These headed pins are captured with a C-clip on one end. When installed they prevent the walk-out of both the hammer and trigger pins.

\$5⁰⁰



H11 AR Field Kit. This package includes a hammer and spring, firing pin and retaining pin, extractor and spring, disconnecter and spring, buffer detent and spring, two gas tube roll pins, a set of three gas rings. This handy kit will fit inside stowaway pistol grips.

\$32⁰⁰



AR Parts

M4S MIL4 Style Handguards. Made from a polymer with single black heat shield liners. A popular upgrade for any carbine to give it that current military MIL4 look.



\$18⁰⁰

F6 AR Style A2 Rifle Handguard. Include aluminum heat shields.

\$15⁰⁰

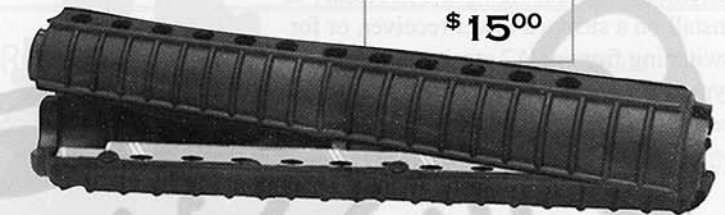

F9 Carbine Handguards. Plastic polymer handguards with aluminum heat shields. Carbine and CAR15 fitting.

\$15⁰⁰



F4 Gas Tube. Made from stainless steel tubing. Available in standard length and carbine length. Please specify when ordering.

CARBINE - \$11⁰⁰

STANDARD - \$13⁰⁰

Harris Bi-Pods Official bi-pod of Olympic Arms.

Harris Bi-Pods mount to our match handguard through a standard bi-pod stud, standard plastic handguards and a Harris universal bi-pod adapter, or the Olympic Arms FIRSH handguard system with an Olympic Arms BPM. It also provides a built in bench rest for superior handling and accuracy in almost any situation. Legs are spring loaded to swing up and out of the way and are adjustable for height and angle. The S-Series Harris Bi-Pod articulates and swivels at the mounting base allowing for leveling of your rifle on an uneven surface.

HBP-1 Bi-Pod - **55⁰⁰**

HBP-S S-Series Bi-Pod - **76⁰⁰**

HBP-#5 Harris #5 Adapter - **9⁰⁰**



F5A Complete Delta Ring Assembly. Includes delta ring, weld spring, snap ring, hook, and roll pins.

\$14⁰⁰

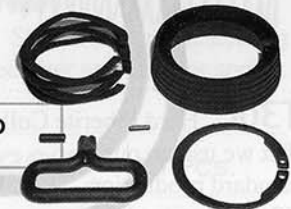

AR82 Reversible Safety Selector. Also available for full auto rifles. Please call our Customer Service Team for details.

\$16⁰⁰



WG The 'Wedgie'. Our little red accessory that fits in the rear of your lower receiver underneath the rear takedown pin. It provides a tighter fit between the upper receiver and lower receiver. Usually not needed with Olympic Arms forged receivers, but quite handy with most others. Available individually packed, or in a retail package.

Code	Description	Cost
WG-A	Wedgie 1-9 Pieces	\$0 ⁷⁵ per piece
WG-B	Wedgie 10-99 Pieces	\$0 ⁶⁹ per piece
WG-C	Wedgie 100+ Pieces	\$0 ⁵⁹ per piece
WG-10	Wedgie 10 Pack	\$7 ⁹⁵ per pack



AR Parts

Carbine Buttstock Assemblies. All assemblies include new parts necessary to install on a stripped lower receiver, or for switching from an A2 stock to a carbine type. *Please specify collapsible or non-collapsible, there is no standard.*

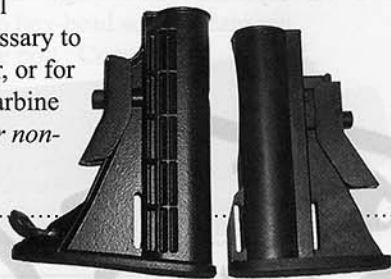

T30AM4 Aluminum MIL4 Buttstock. This assembly is an Olympic Arms exclusive with a redesigned style for strength, and comfort. Available in collapsible form only.



\$69⁰⁰



T30C-MIL4 Hard Fiberite MIL4 Style Collapsible Carbine Stock. Strong, rigid, lightweight.

\$52⁰⁰

T30C Hard Fiberite Collapsible Carbine Stock. The same stock that we use on our standard production rifles. Strong, rigid, lightweight.

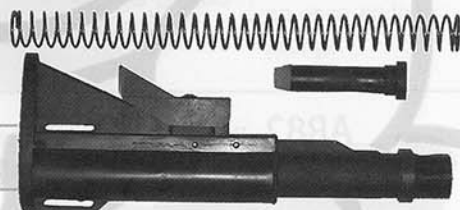

\$43⁰⁰

T30D Extended Receiver Tube. This four position collapsible stock receiver tube has been extended 1.25". Though not just a standard length four position tube, it is actually longer than other manufacturers six position tubes.

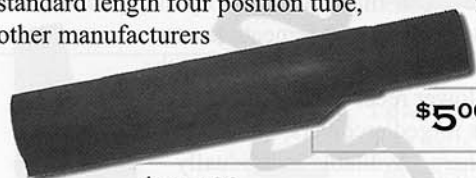

\$5⁰⁰ - AS UPGRADE

\$25⁰⁰ - SEPARATELY

H13 Black Nylon Sling. This is a 1" wide nylon sling in the GI style with buckles on both ends.



\$4⁰⁰

T31 Standard Trapdoor A2 Buttstock Assembly. Includes all new parts necessary to install the stock on a stripped lower receiver. Parts include the buffer, buffer spring, standard trapdoor stock, receiver extension tube and screw.

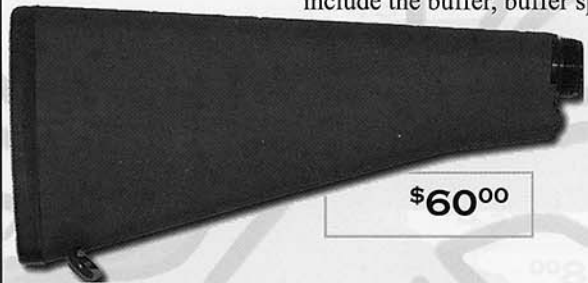

\$60⁰⁰

H24 Stock Spacer Kit. Add one full inch to your AR15 or M16 length of pull. Fits standard A2 buttstock only. Kit includes plastic stock spacer, extra long buttstock screw and buffer tube spacer.

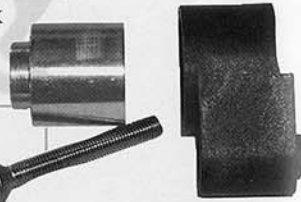

\$8⁰⁰

H12 Standard 10 Round Magazine. Includes bottom, spring, and follower.

\$12⁰⁰

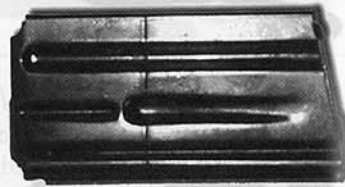

H12-30 Standard 10 Round Magazine. Includes bottom, spring, and follower.

\$18⁰⁰

H125 Five Round Magazine. For use in your 5.56 or .223 AR style rifle. Great for bench rest use or for hunting.



\$13⁵⁰

GF Green Follower. The popular and upgraded follower for GI 30 round AR magazines. This follower improves feeding and reduces failures.



Code	Description	Cost
GF-A	1-500 Pieces	\$0 ⁷⁵ per piece
GF-B	501-1000 Pieces	\$0 ⁶⁹ per piece
GF-C	1001-5000 Pieces ..	\$0 ⁵⁹ per piece
GF-D	5001+ Pieces	\$0 ⁴⁹ per piece

GF10 Green Follower Retail 10 Pack. Ten green followers vacuum packed in lots of ten.



\$7⁹⁵

AR Parts ESpring® Technology

New spring technology has been used at Olympic Arms for several years now. This new ESpring® technology combines the latest in engineering expertise and metallurgy. New metal alloys are available which allow results not even imaginable a decade ago. These new ESpring items may be more expensive than you may be accustomed to, but guarantee they will get the job done and not wear out like standard springs.

AR11B ERing Gas Ring. Another ESpring® technology. This one-piece gas ring is made from a proprietary material that will withstand the most torturous conditions. The ERing's single piece construction prevents gas ring alignment (which leads to gas leakage). This ring will make any AR15/M16 more reliable.



\$6⁰⁰

HTU High Tech Upgrade Kit. This bag of small parts will make a significant improvement to any AR's reliability through ESpring® technology. Kit includes one universal compression washer, two ESpring's, two ERings, and five EXrings.



\$25⁰⁰

ESEJ Made from ESpring® proprietary metal alloy material, this ejector spring is absolutely the best available. Tested by the military under severe and stressed situations. Even after 9,000 rounds of sustained full automatic fire this ejector spring didn't fail.



\$4⁰⁰ - EACH

\$42⁰⁰ - DOZEN Pcs.

AR42C Universal Compression Washer. This compression washer replaces the need for the expensive and sometimes hard to use peel washers for installing flash suppressors or muzzle brakes which require indexing. Use this compression washer with any flash suppressor or muzzle brake. Simply thread the unit on, align as needed, and you're done. *Reusable multiple times even after being torqued on!*



\$3⁰⁰ - EACH

\$32⁰⁰ - DOZEN Pcs.

EXRING EXring Polymer Extractor Assist. A vast improvement over similar products, the EXring is 'x' shaped in the cross-section. This design gives added strength to the extractor as is needed in many AR style rifles. If your AR is having extraction problems, try out the EXring, it may be the solution.



Shown here is the EXring installed over an extractor spring.

\$1⁰⁰ - EACH

\$20⁰⁰ - 25 Pcs.

.22 Conversion Kit For .223 Caliber Rifles

RFA .22 Rimfire Adapter. Though not as accurate as our 22+17 Solution system this conversion kit quickly lets you change your rifles caliber from .223 to a .22. The bolt carrier assembly installs quickly into your rifle and works with all standard mil-spec AR parts. The ammunition is fed from a standard magazine through a magazine adapter. The magazine adapter inserts into a standard magazine and can hold ten rounds.

Extra magazine inserts may be available, please call our Customer Service Team for details.



PLEASE CALL FOR PRICES AND AVAILABILITY

Aluminum Free Floating Handguards

Match style in a tubular design removes pressure on the barrel. The handguard threads onto an included barrel nut for simple installation. All lengths are made from aluminum extrusion and are knurled in the center for a sure grip.

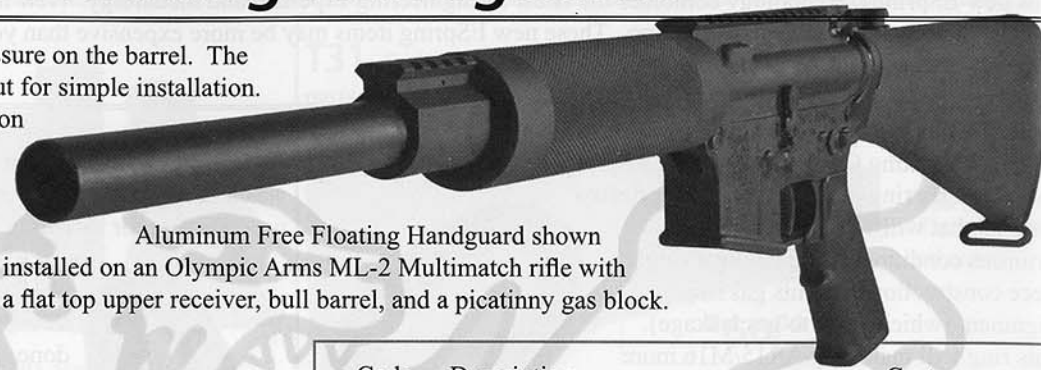

Aluminum Free Floating Handguard shown installed on an Olympic Arms ML-2 Multimatch rifle with a flat top upper receiver, bull barrel, and a picatinny gas block.



Each aluminum free floating handguard includes a new barrel nut for installation.



F23A Super short length handguard. Design to fit 6.5" barrels and still knurled in the center. Same handguard is fitted on the Olympic Arms OA-93 AR pistol.



F8A A carbine length handguard, but still free floating over the barrel.

Code	Description	Cost
F7A	Fits 20" Barrels And H-Bar Rifles.....	\$43 ⁰⁰
F8A	Fits 16" Barrels And Carbines.....	\$35 ⁰⁰
F23A	Fits Pistol ARs and SBRs.....	\$30 ⁰⁰



F7A Standard match length for target rifles. Best fits 20" barrels.

FIRSH Handguards Free Floating Integral Rail System Handguard

FIRSH Specifications:

- Aluminum Extrusion
- Single Piece Tubular Design
- Picatinny Standard Rails
- Four Rails On All Four Sides

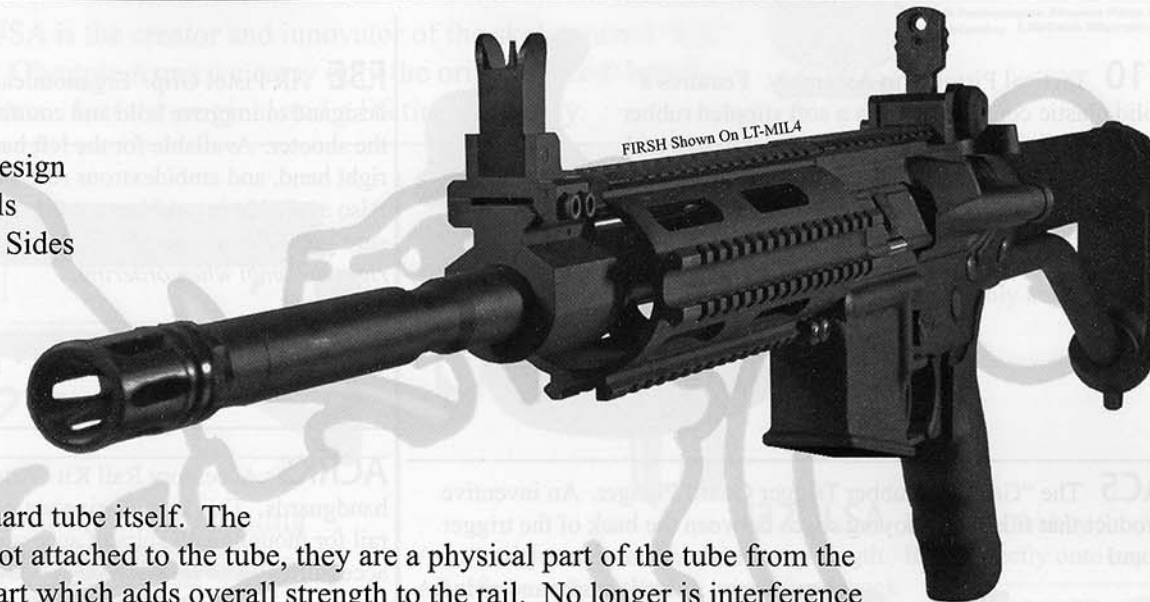

Starting with an aluminum extrusion, the FIRSH handguards derive a portion of their name from the fact that the rails are *integral* to

the handguard tube itself. The rails are not attached to the tube, they are a physical part of the tube from the start which adds overall strength to the rail. No longer is interference from bolts or screws an issue. The FIRSH attaches using a threaded barrel nut and can be positively locked in any rotated position desired.

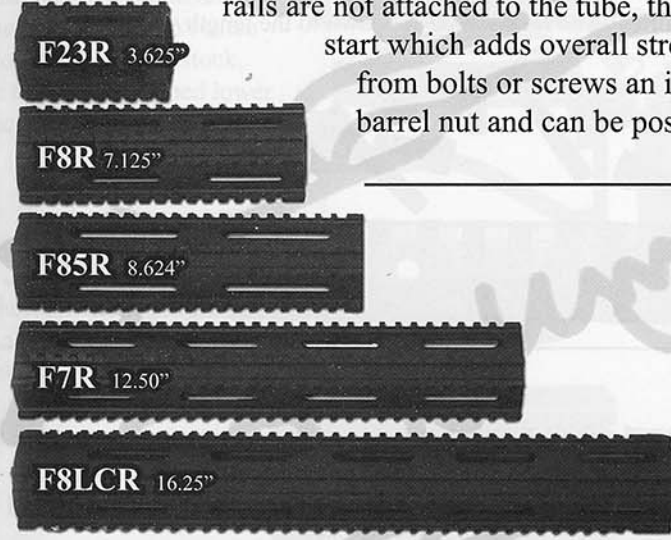

Code	Description	Cost
F23R	Fits AR Pistols and SBR's.....	\$65 ⁰⁰
F8R	16" Barrels and Standard Carbines.....	\$84 ⁰⁰
F85R	Mid-length Barreled Carbines.....	\$95 ⁰⁰
F7R	20" Barrels and H-Bar Rifles.....	\$99 ⁰⁰
F8LCR	Fully Covers 16" Barrels.....	\$129 ⁰⁰

FIRSH Handguard Accessories

SR1 Scope Rings. Some of the best and most versatile scope mounts on the market. They mount to any picatinny standard system, including our flat top uppers and the FIRSH handguard. Made from billet aluminum with quick lock screws and 1" inserts.

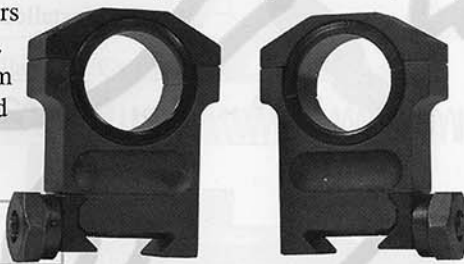

\$39⁹⁵

BPM Bi-Pod Mount. Machined from solid aluminum extrusion. Attaches to picatinny rails using two set screws and can be used as either a bi-pod mount or as a side sling mount.



\$18⁰⁰

BPM-S Side Sling Adapter. Machined from solid aluminum extrusion, and suitable for use in mounting side sling adapters.

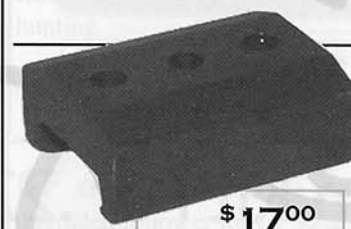

\$17⁰⁰

VPG Vertical Pistol Grip. Machined from billet aluminum and secures with a serrated lock nut. Mounts to all picatinny standard rails, but designed for best use with the FIRSH system. This tactical grip is ergonomically contoured and ribbed for a positive feel. Also available with a foam covered grip for a comfortable and positive hold.



\$34⁵⁰

VPG-F Foam Hold VPG - \$39⁰⁰

SR2 Scope Rings. A new offering from Olympic Arms. These sleek mounts are very similar to the SR1 mounts but trimmed down and lightweight.



\$17⁹⁵

F11 Detachable Carry Handle. Match grade rear sight, can be used on any picatinny standard upper receiver or rail. It is often mounted directly to the FIRSH and used as a scout type of sight.

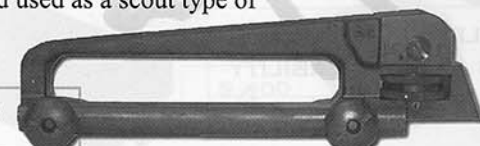

\$79⁰⁰

FIRSH Gen-II



\$199⁰⁰

F8R-GII This FIRSH system was designed for rifles which have flash suppressors permanently attached to the barrel. This is a four piece system which installs directly over the delta ring assembly.



Each FIRSH free floating handguard includes a new barrel nut for installation.

The FIRSH handguard installs easily with a barrel wrench and a few other standard tools.



Ergo® Brand Accessories

F10 Tactical Pistol Grip Assembly. Features a solid plastic core coated with a soft stippled rubber surface. The adjustable palm shelf is standard and comes complete with hex head pistol grip screw.



\$44⁰⁰

F3E AR Pistol Grip. Ergonomically designed to improve hold and comfort for the shooter. Available for the left hand, right hand, and ambidextrous rifle owners. Also available in a rubber coated sure grip. *Please specify left, right, or ambi when ordering*



\$15⁰⁰

F3ESG Sure Grip - **\$19⁰⁰**

AC5 The "Gapper" Rubber Trigger Guard Plunger. An inventive product that fills the annoying space between the back of the trigger and the front of your pistol grip. Installs easily and reduces contact with the lower receiver.



\$2.49 EACH

ACRKS Accessory Rail Kit. Attaches to standard military style handguards. This kit will give your standard handguards a picatinny rail for mounting all sorts of accessories, including our FIRSH accessories. The rails can be cut down to the length you need.

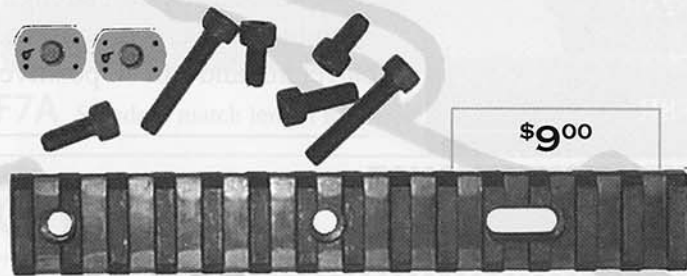

\$9⁰⁰

AC2 Rail Panel Covers. These covers are pliable, yet rugged and fit any standard picatinny rail system. The panels are made from vulcanized rubber and work especially well on the FIRSH handguard system from Olympic Arms. Multiple colors available include: black, olive drab (OD) green, and new coyote brown. The rail panels come in three different sizes and two different styles. The sizes are: single panel, double panel, and triple panel as shown below. The two different styles are solid and vented as shown below. *Please specify color when ordering. Save more, buy a dozen.*



AC2 panels shown on a FIRSH handguard with a vertical pistol grip.

AC2L vented panels shown on a FIRSH handguard with a vertical pistol grip.

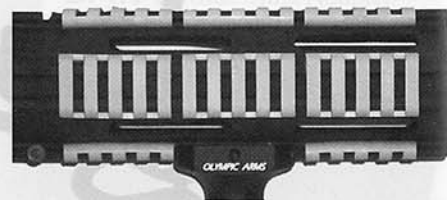

AC2VP Rail Panel Cover Variety Pack. Enough panel covers for all sides of a full carbine length FIRSH handguard. Includes a variety of sizes for covering your handguard. *Sizes of panels may vary.*

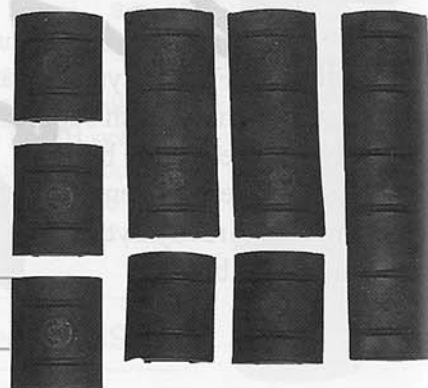

\$28⁰⁰

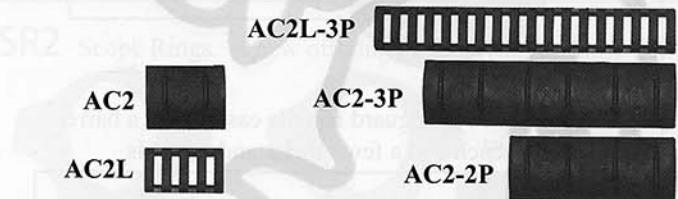

Code	Description	Cost
AC2	Single Panel Solid	\$2 ⁵⁰
AC2D	Single Panel Solid Dozen Pieces.....	\$28 ⁰⁰
AC2-2P	Double Panel Solid.....	\$5 ⁰⁰
AC2-3P	Triple Panel Solid.....	\$7 ⁵⁰
AC2L	Single Panel Vented.....	\$2 ⁵⁰
AC2LD	Single Panel Vented Dozen Pieces	\$28 ⁰⁰
AC2L-3P	Triple Panel Vented	\$7 ⁵⁰

ACE® Brand Specialty Stocks



Bob Weir, CEO of Ace Ltd USA is the creator and innovator of the skeletonized "FX" stocks on today's market. At Olympic Arms we carry only the original Ace® brand products. No copies, no imports. Just the original and a lifetime warranty.

T32 FX Stock. This Ace stock bolts directly onto any AR rifle or carbine that has an A2 stock assembly already.

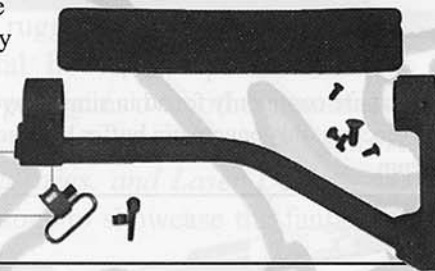

\$65⁹⁵

T32A FX Stock Assembly. Includes all the parts needed to switch from a collapsible stock, or to outfit a stripped lower receiver.

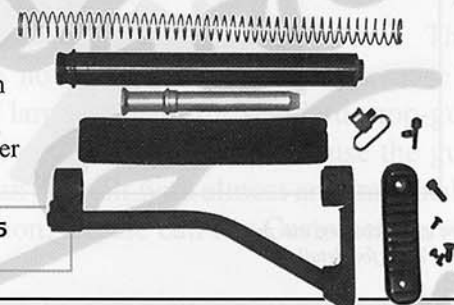

\$82⁹⁵

T32S FX Stubby Stock. Short entry length buttstock. Bolts directly onto any AR rifle or carbine that has an A2 stock assembly already.



\$69⁹⁵

T32SA FX Stubby Stock Assembly. Includes all parts needed to switch from a collapsible stock, or to outfit a stripped lower receiver.



\$98⁹⁵

T32UL Ultralight Stock. Bolts directly onto any AR rifle or carbine that has an A2 fixed stock assembly already.

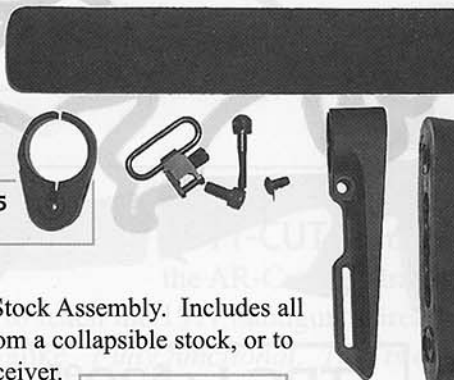

\$59⁹⁵

T32ULA Ultralight Stock Assembly. Includes all parts needed to switch from a collapsible stock, or to outfit a stripped lower receiver.

\$82⁹⁵

T32ULS Ultralight Stubby Stock. An ultralight stock with a short entry length. Bolts directly onto any AR rifle or carbine that has an A2 fixed stock assembly already.



\$65⁹⁵

T32ULSA Ultralight Stubby Stock. An ultralight stock with a short entry length. Bolts directly onto any AR rifle or carbine that has an A2 fixed stock assembly already.

\$87⁹⁵

T32SO Ace SOCOM Collapsible Stock. Made from aluminum. Lightweight with four locking positions. Includes all parts necessary for installation onto a stripped lower receiver. Features two slots for slings, a rubber back, and a foamed extension tube. This stock is both comfortable and durable.



\$172⁰⁰



K3B-MIL4 w/ Ace Ultralight Stubby Stock (T32ULS).



K3B-MIL4 w/ Ace Ultralight Stock (T32UL).



K3B-MIL4 w/ Ace FX Stubby Stock (T32S).



K3B-MIL4 w/ Ace FX Stock (T32).

Pneumatic Recoil Buffer

AC4 Pneumatic Adjustable Recoil Buffer. *Tried, tested, and proven!* Born out of military test, this recoil buffer completely eliminates the need for the standard recoil spring and buffer found in all AR15/M16 style rifles. The AC4 is adjustable so that one model can now be utilized on .223, 5.56 NATO, pistol caliber, and a number of alternative rifle cartridges.

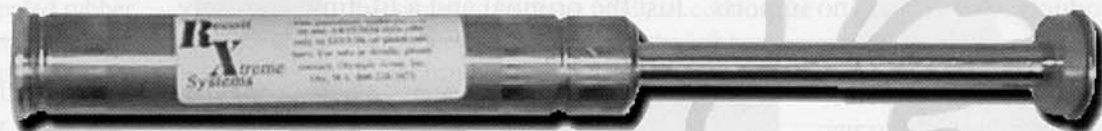

This air-charged buffer has been tested from -60°F to +140°F and worked without problems. Because it is air charged, there are no messy leaks that are commonly found in similar hydraulic products which have historically proven to fail. More than improving feeding, extracting, and ejecting, this pneumatic buffer has been shown to reduce the cyclic rate of a military M4 carbine from approximately 620rpm down to 460rpm.

The AC4 pneumatic recoil buffer is also great for CMP and hi-power rifles as it reduces recoil and muzzle climb giving increased reliability during matches. With the adjustability for suiting your individual needs via the hex head screw on the face of the buffer. Installation is simple: remove your current GI or other antiquated buffer system and insert the AC4 in it's place. No tools needed for installation!



Because of impending production improvements the new lower price for 2005 was not available at the time this version of the catalog was made. Please call our Customer Service Team for details.

AC4: PLEASE CALL MSRP

Tri-Pod Grip

TPG Tri-Pod Grip. One the most versatile and exciting new accessories released by Olympic Arms. This handy and effective item has two main uses. With the legs extended out it becomes a tri-pod for anything from rifles to cameras. Retract the legs into the shaft and the TPG becomes a grip for whatever it is attached to.



Features include three retractable legs, steel ball joint for strength, all aluminum body, fully adjustable for pan, tilt, and swivel with one lock, adjustable tension with one lock, knurled collar for positive locking, comfortable foam rubber grip, standard 1/4-20 threads, and a picatinny mount on request at no additional cost.

The legs are held inside the grip by a small magnet. To extend the legs, point the TPG with the legs facing down and snap the grip down. The magnet will release and the legs will extend. To retract the legs, simply push them up into the grip until the magnet grabs a hold.

When ordering specify the short or long model and your choice of the BPM Bi-pod Mount, or the SSM Side Sling Mount. *If no mount is specified, no mount will be shipped, and no discount will be given.*

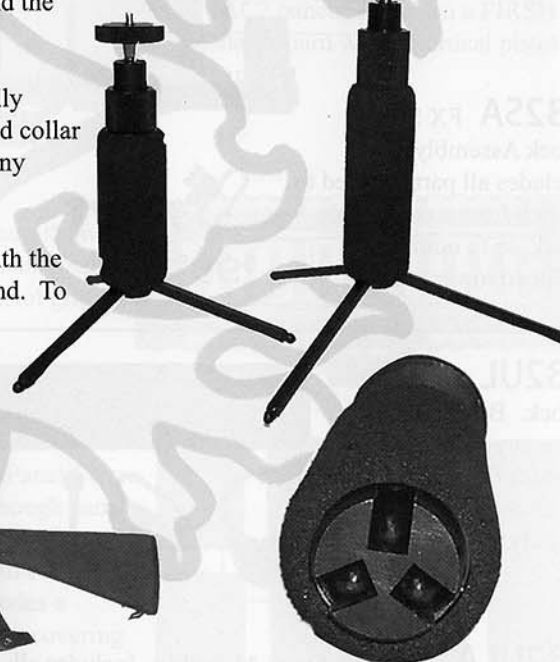

TPG-S: \$29⁹⁹ MSRP

TPG-L: \$29⁹⁹ MSRP

Prop Guns & Pro Training Aids

Prop Guns In today's firearms market there is a large trend toward training and security. There is also a growing need in Hollywood for movie prop guns. Olympic Arms has been supplying true firing weapons, blank firing weapons, and movie prop guns for many years now. Some of our rifles and pistols have been in big-screen movies such as *Clear and Present Danger, Eraser, Batman Returns, Bad Boys, The Professional, The Rock,* and more. The studios that rent and purchase our firearms routinely comment on the unique quality, ruggedness, and believability of our movie prop guns. Even the largest Hollywood prop rental house, Independent Studio Services, prefers Olympic Arms prop guns over other manufacturers. Rifle accessory manufacturers such as *Blackhawk Industries, Quake Industries, Falcon Industries, and Laser Devices* use our prop guns in their own catalogs to showcase the fantastic accessories they make.

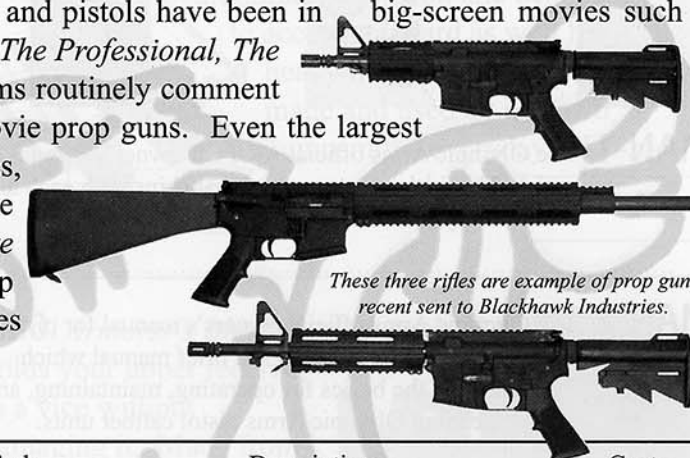

These three rifles are example of prop guns recent sent to Blackhawk Industries.

All prop guns are **non-firing** museum quality replicas. They are non-guns and do not require an FFL for purchase or transfer. Because of large demand for standard prop-guns most are not listed in our catalog. Also, because the guns are non-firing, they can be built with almost any imaginable option and configuration. Please call our Customer Service Team for details.

Code	Description	Cost
CAR15-PROP	Standard Carbine.....	\$395 ⁰⁰
M16A2-PROP	Standard M16A2 Replica...	\$425 ⁰⁰
M16M4-A3-PROP	M16 M4 Flat Top.....	\$595 ⁰⁰

Call our Customer Service Team for a quote based on your specific needs. We can add almost any option to a prop gun!

AR-CUT AR Training Aid. Nothing is more effective in training than a full cut-away view of a functioning firearm training aid. Fully visible fire control components and bolt/chamber area make this an excellent training tool for any agency or department. *Cut-away, fully functional, requires an FFL.*



AR-CUT: \$1,100⁰⁰ MSRP

T3-CUT Fire Control Training Aid. The T3-Cut is a training aid cut-away non-gun lower receiver forging. It is milled to accept the fire control components for training with regards to the hammer, disconnect, trigger, engagement, and for fitting custom trigger components. *No FFL required.*



The mag well is solid, and the takedown pin holes have not been drilled. The rear are for a receiver tube is solid.

T3-CUT: \$89⁰⁰ MSRP

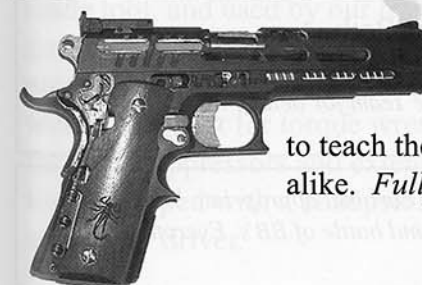

1911-CUT As detailed, functional, and beautiful as the AR-Cut, this training aid is the absolute best way to teach the 1911 handgun. Great for teaching beginners and pros alike. *Fully functional. This is a Series 70 1911 pistol.*

1911-CUT: \$995⁰⁰ MSRP

Owner's Manuals For AR15® M16® Style Rifles

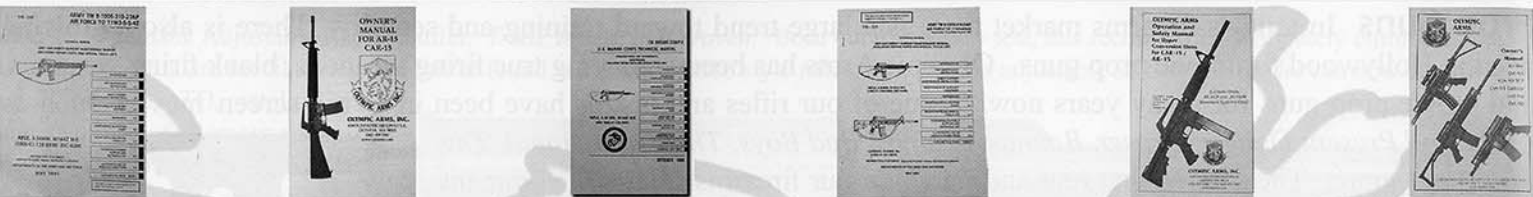

MAN-1 The Olympic Arms official AR/PCR owner's manual. This is the same manual that ships with each and every rifle that Olympic Arms manufactures.

\$3⁰⁰

MAN-2 The Olympic Arms official owners' manual for pistol caliber upper receiver conversions. This is a brief manual which covers the basics for operating, maintaining, and cleaning Olympic Arms pistol caliber units.

\$2⁰⁰

MAN-3 This manual contains all the original OA-93 information, including exploded parts views with parts numbers, descriptions. This is the same manual that ships with OA-93 upper receivers and OA-98 pistols.

\$4⁰⁰

H7 Marine Corp Manual. A reprint copy of the United States Marine Corp Technical manual. Covers everything from complete disassembly and reassembly to torque specifications and beyond. We recommend that all serious AR owners have this manual.

\$7⁰⁰

TM-220 A combo Army and Air Force manual. This handbook as with all military manuals is very detailed. Covers only the M16A2 standard issue rifle.

\$9⁰⁰

TM-225 A composite of the Army TM 9-1005-319-23&P and the Air Force TO 11 W3-5-5-42 books. This is a comprehensive manual for both the M16A2 and the M16A4 Carbine rifles.

\$11⁰⁰

Airsoft CAR-97M4



Used by gamers, and purchased by collectors for years. Airsoft products have made their own place in the firearms industry and sales of Airsoft products tripled since 2000. A partnering between Team SD and Olympic Arms brought about an Airsoft version of our K3B-MIL4. It looks and functions like many other Airsoft products and check out our standard features:

- All metal construction. No plastic substitutions.
- Two piece gear box construction.
- Removable gear box, just like a real AR style bolt carrier assembly.
- Select fire with full automatic electronic firing.
- 5-Position collapsible stock.
- Picatinny flat top with detachable carry handle.
- Licensed Olympic Arms logo.
- High capacity 400+ round magazines.

Code	Description	Cost
AS01	CAR-97M4. Collapsible Stock.	\$286 ⁰⁰
AS02	CAR-97M4. A2 Buttstock.	\$286 ⁰⁰
AS01-P1	Starter Kit. Collapsible Stock.	\$322 ⁹⁵
AS02-P1	Starter Kit. A2 Buttstock.	\$322 ⁹⁵
BAT2	8.4 Volt Battery For AS02.	\$44 ⁹⁵
BAT6	9.6 Volt Battery For AS01.	\$33 ⁵⁰
ECL	Charger Unit For BAT2.	\$6 ⁹⁵
ECS	Charger Unit For BAT6.	\$6 ⁹⁵
ECF	Fast Charger. For Both BAT2 And BAT6 Packs.	\$45 ⁹⁵

Please call our Customer Service Team for details on Air Soft magazines and ammo.

Starter kits: Includes the Airsoft carbine, appropriate battery and battery charger, and a 1,000 round bottle of BB's. Everything you need to get started.

Battery packs and charging systems sold separately. No FFL required. Must be at least 18 years of age to purchase.



AR & PCR Gunsmithing Tools

H5 Headspace Gauges. A necessary tool for the serious gun owner. Available each or as a set.

Code	Description	Cost
H5A	Go Gauge.....	\$16 ⁰⁰
H5B	No-Go Gauge.....	\$16 ⁰⁰
H5C	Field Gauge.....	\$16 ⁰⁰
H5S	Set of gauges.	\$45 ⁰⁰

AC1 Chamber Cleaning Kit. An excellent tool to add to your armorer's kit, or to just have around the bench. This specially designed AR rifle chamber cleaning kit is the tool for quick and effective cleaning.

\$9⁹⁵



H2 Dual Slot Vise Jaw Blocks. Manufactured from aluminum extrusion and designed to accept standard as well as heavy barrels. Olympic Arms made and used by our own gunsmiths everyday. Will not accommodate bull barrels.

\$6⁰⁰

H20 Armorer's Block Kit. Securely holds your upper receiver in a vice without damaging it. Made from a strong polymer, and includes a poly insert to prevent receiver pinching. Works with A2 uppers or A3 style flat top uppers.

\$32⁰⁰



H3 Collapsible Carbine Stock Wrench. Great for tightening the lock ring on your collapsible stock receiver tube. Also works as a 1911 bushing removal too.

\$3⁰⁰

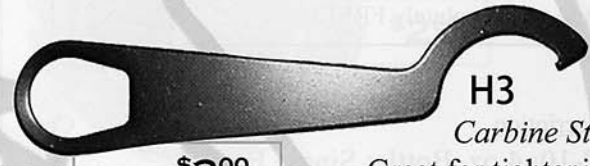

H4 Sight Tool / Takedown Punch. Handy tools which make adjusting your sights easy. Also work great at punching out the takedown pins on your rifle. Available as four prong or five prong. Please specify four or five prong.

\$5⁰⁰



H28 Universal Barrel Wrench. An Olympic Arms made tool, and used by our own gunsmiths. Designed with an integral handle, multi-point head as well as a three prong design. Machined with a 1/2" port for torque wrench specs, and notched for flash suppressors and extension tubes. The H28 is finally capped with a collapsible stock spanner wrench and screw driver.

\$18⁰⁰

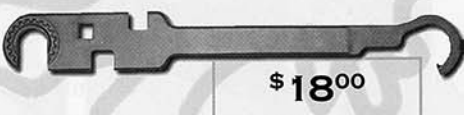

Full size sight tools and takedown punches make for easy adjustments and punching.

AC74 Full Size 4 Prong Sight Tool. **\$9⁹⁸**

AC75 Full Size 5 Prong Sight Tool. **\$9⁹⁸**

AC8 Delryn Punch. **\$5⁹⁸**



Cleaning & Lubricating Products

Firepower FP-10 *We just cannot say enough good things about this product.* It has a military stock number (NSN 6850-01-408-4531) and performed better than all other issued lubricants in recent conflicts in the middle east. FP-10 meets all EPA standards which some well known similar products do not. This lubricant is also used by Picatinny Arsenal, is a two time winner of the Gold Medal Best Value Award by the Defense Supply Centers, and has been in the USPFO system since 1998. FP-10 is so highly thought of by many firearms industry members that it is even recommended and sold by Cleanbore.

"...we have arrived at the conclusion that FP-10 is a substantially better product than it's many rivals. FP-10 has performed flawlessly for us..." Cleanbore Ltd.

Ask for a free sample of FP-10 when you place your next order with Olympic Arms. We are so confident you'll like it, we'll give it to you absolutely FREE!



Code	Description	Cost
FP10-4	FP-10; 4 oz. Bottle; Single Bottle	\$3 ⁸⁰
FP10-4C	FP-10; 4 oz. Bottle; Case Of 12 Bottles	\$45 ⁹⁹
FP10-16	FP-10; 16 oz. Bottle; Single Bottle	\$8 ⁸⁷
FP10-16C	FP-10; 16 oz. Bottle; Case Of 12 Bottles ..	\$106 ⁴⁸
FP10-SP	Single Sprayer For 16 oz. Bottle	\$1 ⁴⁹

Receive free sprayers when you purchase a case of 16 oz. bottles!



slip2000 *One step cleaning and lubrication system!* All-in-one products that clean, lubricate, and preserve your firearm. The easy to use slip2000 products will out-clean, out-lubricate, and out-last other similar products. The synthetic systems are environmentally safe, non-toxic, and non-hazardous.

Code	Description	Cost
S2K-D14	725 Gun Cleaner Degreaser 14 oz. Spray Can.....	\$12 ⁷⁵
S2K-D4	725 Gun Cleaner Degreaser 4 oz. Pump Spray Bottle	\$5 ²⁵
S2K-CLP4	Lube, Cleaner, Preservative 4 oz. Pump Spray Bottle	\$6 ⁷⁵
S2K-GL1	Gun Lube 1 oz. Pour Top Bottle	\$2 ⁷⁵
S2K-CLPP4	Lube, Cleaner, Preservative 4 oz. Pour Top Bottle	\$6 ⁷⁵
S2K-CC4	Copper Cutter 4 oz. Pour Top Bottle	\$6 ⁷⁵

Please call our Customer Service Team for the latest prices on slip2000 products.



Olympic Arms Official Accessories

OA7 OD Green Hard Case.

The Olympic Arms branded Daskocil single rifle gun case. Upgraded in 2004. Molded in a military style Olive Drab green.



\$17⁹⁵

OAM-7 Olympic Arms Lapel Pin. The Olympic Arms lion logo engraved in a pewter pin.



\$3⁰⁰

OA-H Olympic Arms Embroidered Hat. Made from 100% cotton with a velcro adjustment band in the back for a universal fit. Will fit most wearers. The hats are embroidered in full color with the Olympic Arms lion logo. Choose from black/black and khaki/dark blue. Price for one hat, please specify style when ordering.



\$9⁰⁰

OA6 All Purpose Sticker. These stickers are made from full color plastic vinyl. Great for windows, cars, gun cases, safes, or anywhere else you think to stick it. Display your Olympic Arms pride. Size is roughly 5" x 7". Three styles available, please specify style.

\$2⁵⁰

Standard The text reads "Meeting The Demands Of The 21st Century".

Stocking Dealer Only available to licensed FFL dealers. Text reads "Stocking Dealer". See photo.

Dealer Distributor Only available to our dealer distributors. Text reads "Dealer Distributor".



STOCKING DEALER



\$10⁰⁰

OA4 Olympic Arms Counter/Armorer's Mat. Also often used as a large mouse pad. Full color printed front on a static free polymer with a 5mm neoprene backing for surface grip. Size is 10" x 13".



OA2 Olympic Arms Patch. A four color patch custom made with the Olympic Arms lion logo.

\$2⁰⁰

OA5 Olympic Arms T-Shirts. Quality, grey/ash colored shirts. Made from heavy weight 100% cotton. Full color Olympic Arms logo on the back and front sides. Multiple sizes available, please check for sizes on hand before ordering.



\$12⁰⁰

A-2 REAR SIGHT ASSEMBLY

T-15 Sold as a unit in the AR Parts section. For individual small parts, see below:

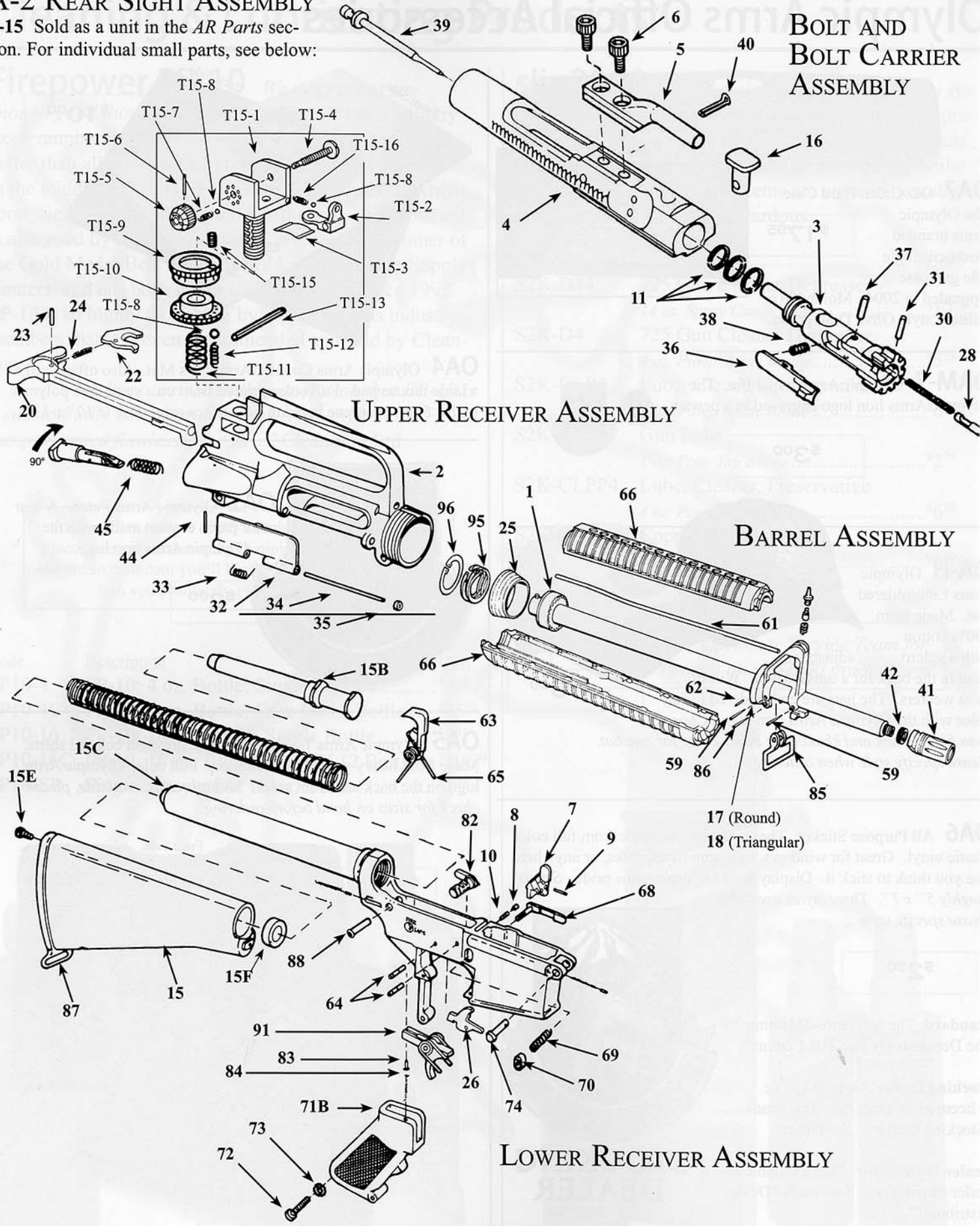

AR Style Rifle Replacement Parts

AR1	Barrel nut.....	\$12.00	AR62.	Gas tube roll pin.....	0.50
AR2	A2 Upper receiver, stripped.....	77.00	AR63.	Hammer.....	11.00
AR3	Bolt, complete (223/5.56 cal).....	43.00	AR64.	Hammer & trigger pin.....	0.80
AR3-9/10/40/45			AR64-H15	H/T pins; Anti-walk type (per set of 2).....	5.00
AR3-310	Bolt, complete, pistol caliber.....	65.00	AR65.	Hammer spring.....	1.00
AR4	Bolt carrier,.....	44.00	AR66.	Handguards (CAR) round w/o liners.....	9.00
AR4FA	Bolt Carrier; Full-auto configuration.....	44.00	AR66A.	Handguard (CAR) round with liners.....	15.00
AR5	Bolt carrier key.....	9.00	AR67.	Handguard snap ring.....	0.80
AR6	Bolt carrier key screw.....	0.50	AR68.	Magazine catch.....	4.50
AR7.	Bolt catch.....	6.00	AR69.	Magazine catch spring.....	0.80
AR8.	Bolt catch plunger.....	0.80	AR70.	Magazine catch button.....	2.00
AR9.	Bolt catch roll pin.....	0.50	AR71A.	Pistol grip assembly A2 stowaway.....	8.00
AR10.	Bolt catch spring.....	0.50	AR71B.	Pistol grip (A2) only.....	7.00
AR11.	Bolt gas rings, set.....	2.00	AR71C.	Pistol grip A2 (GI style).....	7.00
AR11B.	ERing 1 Piece gas ring.....	6.00	AR72.	Pistol grip screw.....	1.00
AR12.	Buffer detent.....	1.50	AR73.	Pistol grip screw washers.....	.50
AR13.	Buffer detent spring.....	.50	AR74.	Pivot pin, front.....	5.00
AR14A.	Butt stock buffer (CAR).....	12.00	AR75.	A1 Rear sight.....	6.00
AR14B.	Buffer spring (CAR).....	4.00	AR76.	A1 Rear sight adjusting screw.....	2.50
AR14C.	Receiver ext. tube (CAR).....	18.00	AR77.	A1 Rear sight detent spring.....	.50
AR14C1.	Extra long (1") CAR receiver ext. tube		AR78.	A1 Rear sight detent.....	.50
	4 position.....	25.00	AR79.	A1 Rear sight leaf spring.....	.50
AR15.	Butt stock (standard) complete.....	65.00	AR80.	A1 Rear sight windage drum.....	3.00
AR15A.	Butt stock (standard) trapdoor.....	35.00	AR81.	A1 Rear sight windage drum roll pin.....	0.50
AR15B.	Butt stock buffer (standard).....	17.00	AR82.	Safety selector.....	11.00
AR15C.	Receiver ext. tube (standard).....	18.00	AR83.	Safety detent.....	1.00
AR15D.	Buffer spring (standard).....	4.00	AR84.	Safety spring.....	0.50
AR15E.	Butt stock screw.....	1.50	AR85.	Swivel, front.....	4.00
AR15F.	Stock spacer, A-2.....	1.50	AR86.	Swivel pin.....	0.50
AR16.	Cam pin.....	4.00	AR87.	Swivel, rear.....	4.00
AR16A.	Cam pin, chrome.....	6.00	AR88.	Takedown pin, rear.....	5.00
AR17.	Cap. handguard front (round).....	4.00	AR89.	Takedown pin detent, rear.....	0.50
AR18.	Cap. handguard front (Tri.).....	4.00	AR90.	Takedown pin detent spring, rear.....	0.50
AR20/T23.	Charging handle, complete.....	20.00	AR91.	Trigger.....	11.00
AR22.	Charging handle latch.....	4.00	AR92.	Trigger guard.....	5.00
AR23.	Charging handle latch roll pin.....	0.50	AR93.	Trigger guard pin.....	0.50
AR24.	Charging handle latch spring.....	0.50	AR94.	Trigger spring.....	1.00
AR25.	Delta ring.....	9.00	AR95.	Weld spring.....	5.00
AR26.	Disconnecter.....	4.00	AR96.	Lock ring.....	5.00
AR27.	Disconnecter spring.....	0.50	AR97.	Receiver plate.....	2.50
AR28.	Ejector.....	3.00			
AR30.	ESEJ Ejector spring.....	4.00			
AR31.	Ejector roll pin.....	.50			
AR32.	Ejection cover.....	8.00			
AR33.	Ejection cover spring.....	.80			
AR34.	Ejection cover hinge pin.....	1.00			
AR35.	Ejection cover hinge pin clip.....	0.50			
AR36.	Extractor.....	10.00			
AR37.	Extractor pin.....	1.00			
AR38.	Extractor spring; HD w/o insert.....	1.50			
AR39.	Firing pin, new.....	7.00			
AR40.	Firing pin retaining pin.....	0.50			
AR41.	Flash suppressor (A-2bird cage).....	4.50			
AR42.	Flash suppressor lockwasher.....	0.80			
AR42C	Universal Compression Washer.....	3.00			
AR44.	Forward Assist. retainer pin.....	0.50			
AR45.	Forward Assist. spring.....	0.80			
AR55.	Front sight base.....	18.00			
AR56.	Front sight detent.....	1.50			
AR57.	Front sight post.....	3.00			
AR57A.	Square front sight post.....	4.00			
AR58.	Front sight post detent spring.....	0.50			
AR59.	Front sight taper pin.....	0.80			
AR60/F4A.	Gas tube (CAR).....	11.00			
AR60-PT.	Gas Tube; Pig-Tail type.....	35.00			
AR61/H4B	Gas tube (standard).....	13.00			

A-2 SIGHT ASSEMBLY PARTS LIST

T15-1	A-2 Sight base.....	7.99
T15-2	A-2 Sight aperture.....	4.49
T15-3	Leaf spring.....	0.89
T15-4	Windage screw.....	1.99
T15-5	Windage knob.....	2.99
T15-6	Windage knob roll pin.....	0.35
T15-7	Windage knob spring.....	0.25
T15-8	Ball bearing.....	.45
T15-9	Elevation wheel cap.....	3.49
T15-10	Elevation adjustment wheel.....	3.49
T15-11	Elevation base spring.....	0.75
T15-12	Elevation wheel ball-bearing spring.....	0.20
T15-13	Sight base elevation lock roll pin.....	0.35
T15-15	Elevation wheel lock screw.....	0.49
T15-16	Sight base constant alignment spring.....	0.20

HIGH TECH UPGRADE PARTS:

HTU Kit	Full kit if high tech upgrade parts.....	25.00
ESEJ	Military tested 10K round ejector spring.....	4.00
AR11B	ERing 1-piece gas ring.....	6.00
EXRing	Poly X-ring extractor tensioner.....	1.00
ESMAG	Titanium 30 round magazine spring.....	12.00

Schuetzen Pistol Works

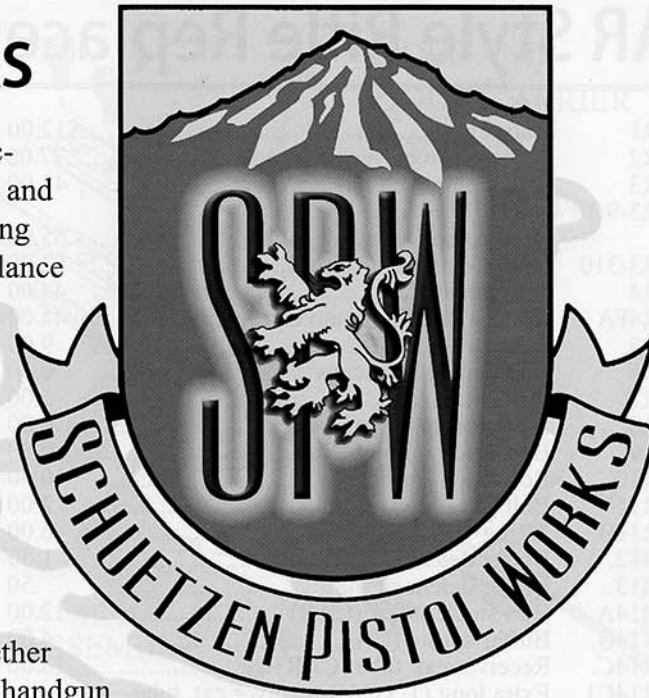

In 1987 Olympic Arms incorporated Safari Arms and began production of 1911 handguns in the form of the now famous Matchmaster and Enforcer pistols. With technological and quality advancements along the way since then the current models bear only a cosmetic resemblance to the original handguns produced prior to those now built in our Olympia, Washington pistol shop.

In 1993 the name Schuetzen Pistol Works was created to differentiate between standard production 1911 handguns and the custom order 1911 handguns we offer. In 2004 the decision was made to stop using the Safari Arms name and to move to the more familiar Olympic Arms trademark.

Built with pride, experience, and quality, no matter the name. Whether you want a production 1911 pistol, or a custom made for you 1911 handgun the pistol you receive will have been overseen by two of the most experienced and skilled pistolsmiths in the country.

In addition to standard Olympic Arms production pistols, the Street Deuce and Journeyman are premium grade pistols from the SPW shop. They are top-notch, high-end pistols just as good and in most aspects better than any other 1911 pistol at any price. *Have your pistol made for you, call our Customer Service Team for details or ask to speak directly with Richard in the pistol shop.*

Our Customer Service Team is often asked if we provide an *accuracy guarantee* with our pistols. The answer is usually no, because we do better. Not only do all 1911 pistols come with a limited lifetime warranty, but you'll also get the sixty day 100% satisfaction guarantee. If within sixty days of receiving your pistol you are not 100% satisfied with it, you can have your dealer return the handgun to Olympic Arms for a full refund.

Our commitment is simple and we are confident that we built the best 1911 45 caliber handguns with which we back with the best warranty in the industry. *Call our Customer Service Team for product and warranty details.*

<u>Model</u>	<u>Page</u>
Whitney Wolverine	49
Matchmaster.....	50
Enforcer.....	51
Cohort	51
Westerner	52
Trail Boss	53
Constable.....	53
Street Deuce.....	54
Journeyman.....	54
Specialty Shop List.....	56

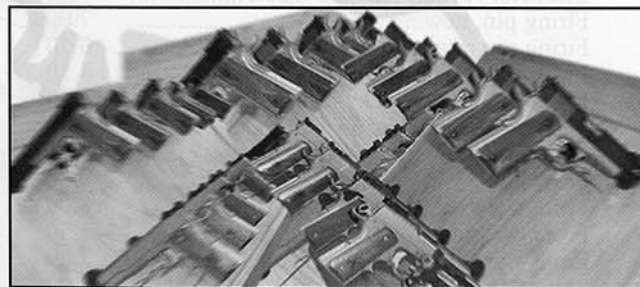

Whitney Wolverine

Here it is again. At Olympic Arms we've been touting the return of the Whitney Wolverine pistol for years, and here it is to begin shipping in late 2004. Not flood, fire, nor earthquake could keep this pistol from seeing the light of manufacturing day. The original Whitney Wolverine pistols first went into production in 1956. They were a huge hit with consumers. The radical 'space age' design was ergonomic on the hand, and pointed quite well for most shooters. With new technology in cast aluminum available after WWII, the Wolverine was a very lightweight and strong handgun. It's shape alone attracted many consumers.

Unfortunately, the Whitney Wolverine pistol quickly went out of production because of distribution problems. To make problems worse a rival pistol was introduced shortly afterwards that sold for just a few dollars less than the Wolverine (remember 1956 dollars not 2004 dollars). Now, fall 2004, and with years of development backing it, the Whitney is being readied for release. The new Whitney pistol will be

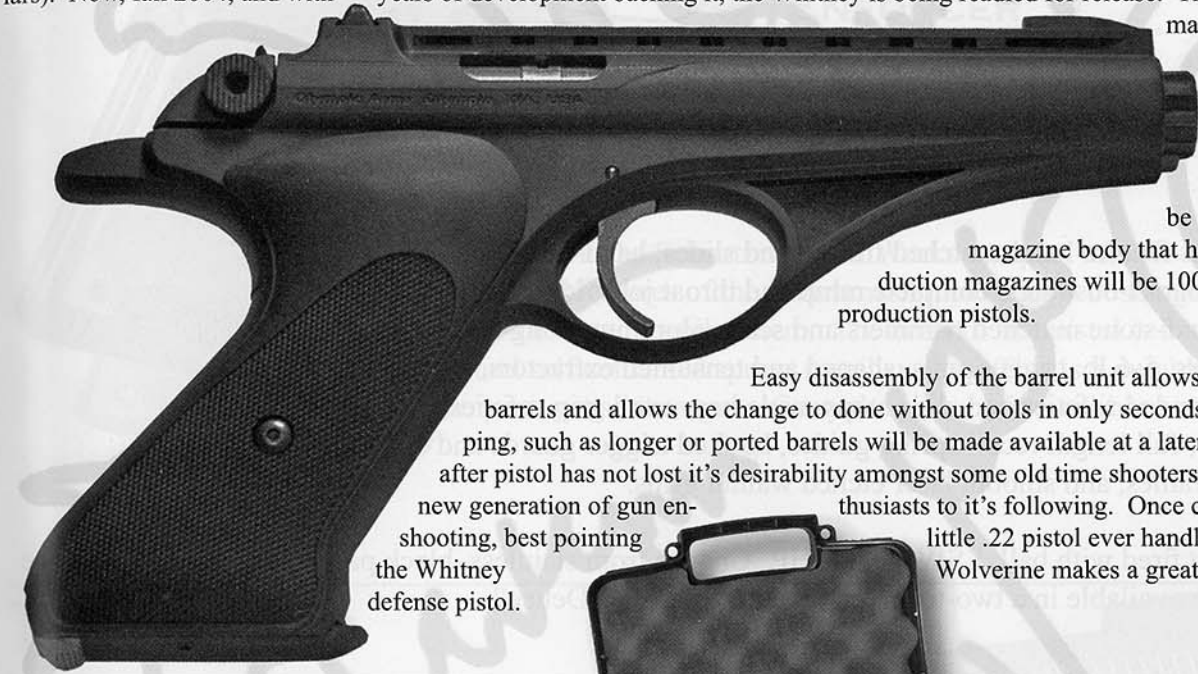

manufactured with a high-strength polymer frame. It is extremely lightweight and very durable as well as molded in a stylish black color. The .22 caliber LR (Long Rifle) ammo will be delivered through an all metal magazine body that houses 10 rounds. Current production magazines will be 100% interchangeable with earlier production pistols.

Easy disassembly of the barrel unit allows for the use of interchangeable barrels and allows the change to be done without tools in only seconds. Optional barrels for swapping, such as longer or ported barrels will be made available at a later date. This once highly sought after pistol has not lost its desirability amongst some old time shooters. Now it will attract an entire new generation of gun shooting, best pointing enthusiasts to its following. Once called, "The most reliable, best little .22 pistol ever handled" by the late Rex Applegate, the Whitney defense pistol. Wolverine makes a great plinker, farm hand, or hoke

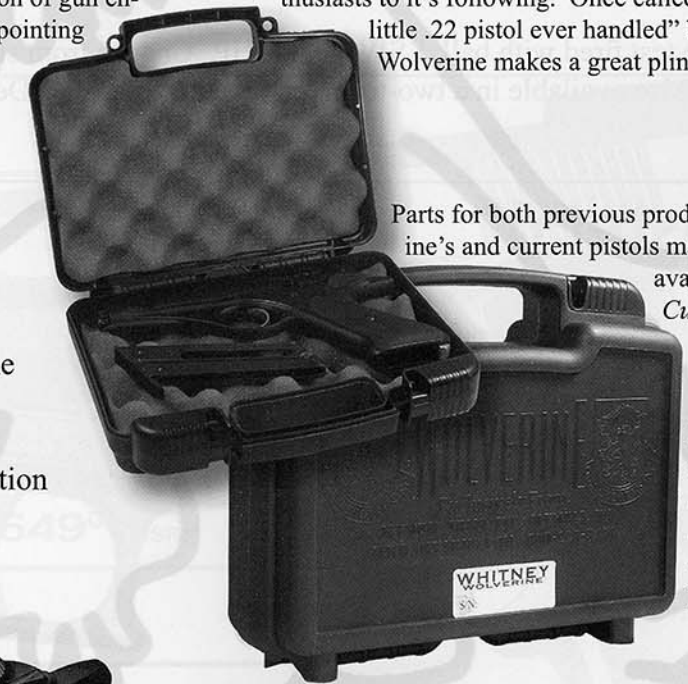

Parts for both previous production Whitney Wolverine's and current pistols made by Olympic Arms are available. *Please call our Customer Service Team for details.*

Shipped with an Owner's Manual and a custom molded dark royal blue case. The case is a limited edition which is branded with a Whitney Wolverine logo.

Whitney Wolverine Specifications:

- Hardened Lightweight Polymer Frame
- Dovetail Rear Sight
- 6" Sight Radius
- Uses .22 Caliber Long Rifle Ammunition
- Capacity: 10 Rounds
- Length: 9" Height: 5.5"
- Empty Weight: 19.2 oz.



WHITNEY WOLVERINE:

\$209⁵⁰
EACH

Please call for pricing on multiple quantity Whitney Wolverine orders.

Matchmaster 5"

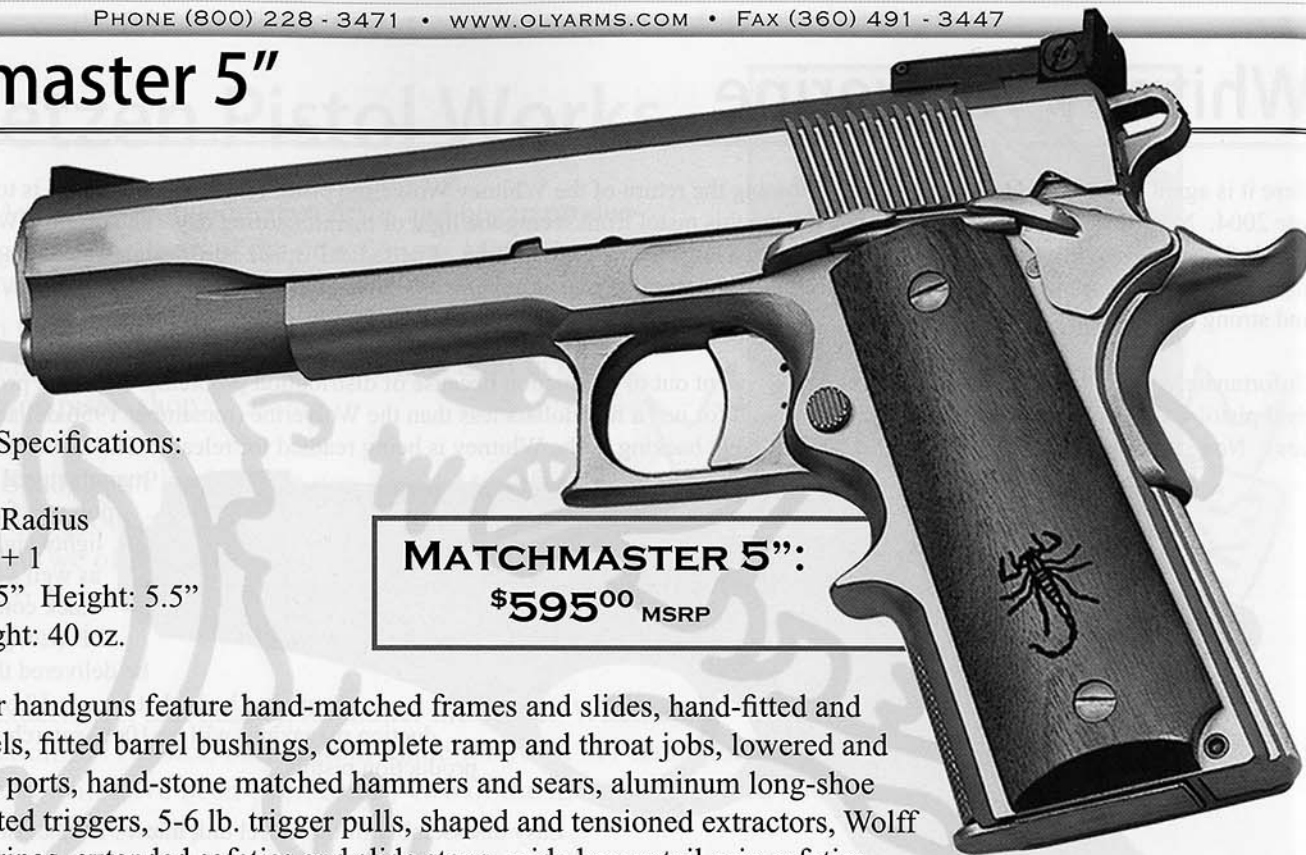

Matchmaster 5" Specifications:

- 5" Barrel
- 6.75" Sight Radius
- Capacity: 7 + 1
- Length: 8.75" Height: 5.5"
- Empty Weight: 40 oz.

MATCHMASTER 5":
\$595⁰⁰ MSRP

The Matchmaster handguns feature hand-matched frames and slides, hand-fitted and headspaced barrels, fitted barrel bushings, complete ramp and throat jobs, lowered and widened ejection ports, hand-stone matched hammers and sears, aluminum long-shoe over-travel adjusted triggers, 5-6 lb. trigger pulls, shaped and tensioned extractors, Wolff 18.5 lb. recoil springs, extended safeties and slide stops, wide beavertail grip safeties, fully adjustable rear sights, full length recoil spring guides, hooked trigger guards and finger-groove front strap frames, and smooth laser etched walnut grips.

Matchmaster series are test fired with ball, LSWC, and JHP. Choose from stainless, black parkerized carbon, or deuce finish configurations. Also available in a two-tone version known as the "Deuce".

Matchmaster 6"

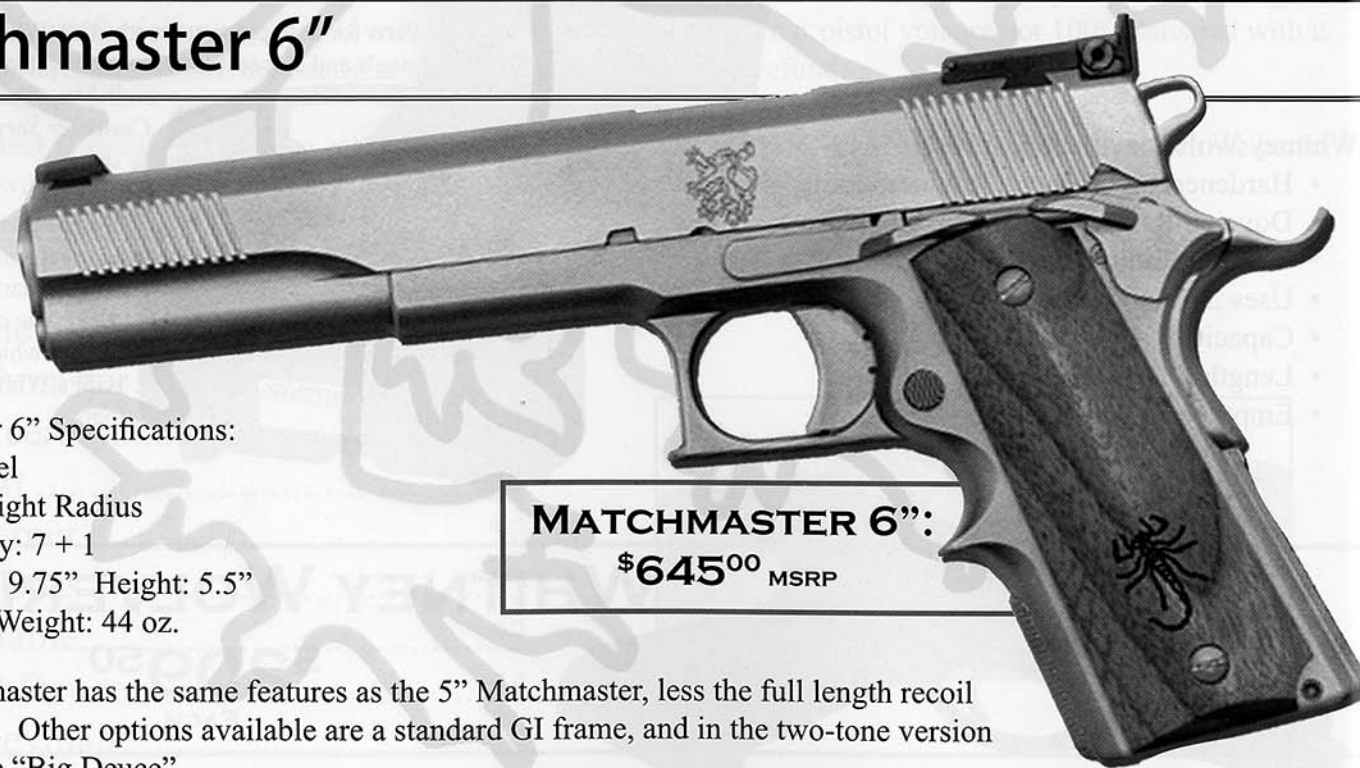

Matchmaster 6" Specifications:

- 6" Barrel
- 7.75" Sight Radius
- Capacity: 7 + 1
- Length: 9.75" Height: 5.5"
- Empty Weight: 44 oz.

MATCHMASTER 6":
\$645⁰⁰ MSRP

This Matchmaster has the same features as the 5" Matchmaster, less the full length recoil spring guide. Other options available are a standard GI frame, and in the two-tone version known as the "Big Deuce".

The Enforcer

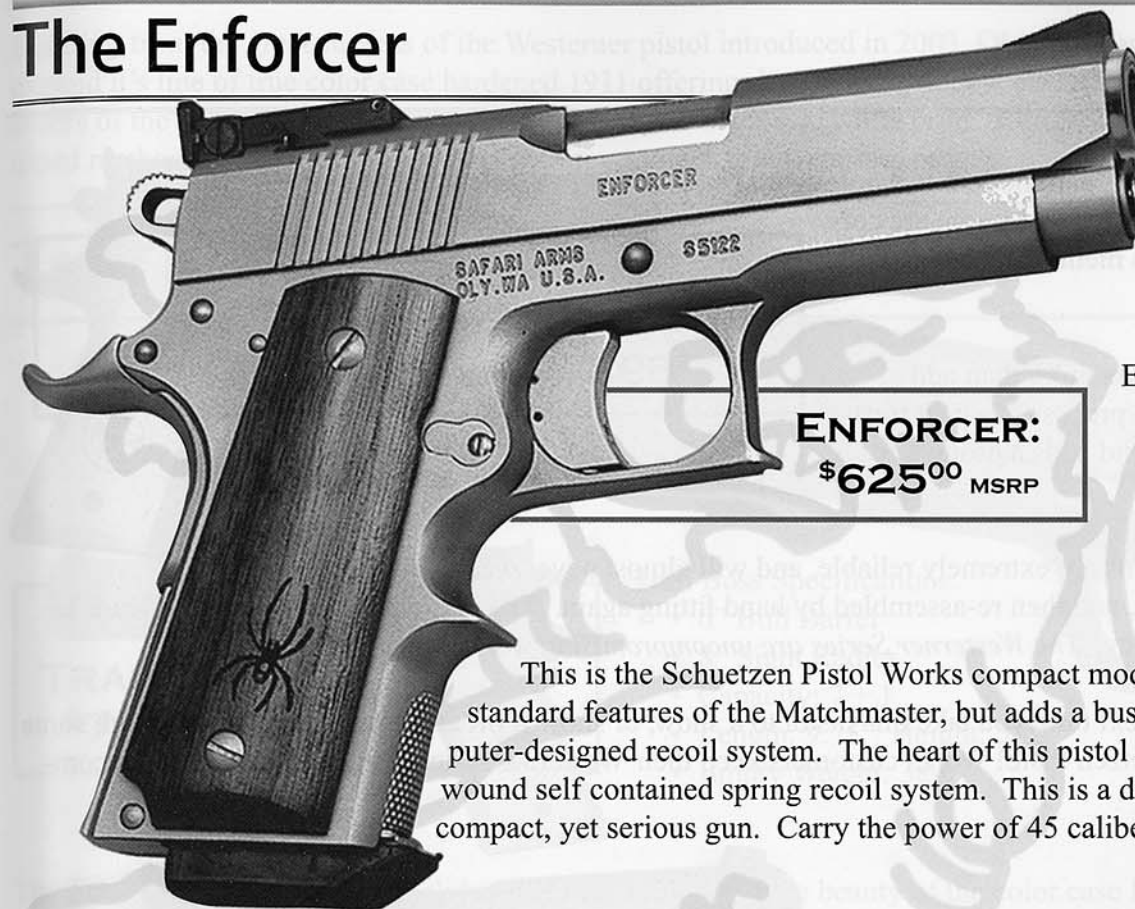

ENFORCER:
\$625⁰⁰ MSRP

Enforcer Specifications:

- 4" Bull Barrel
- 5.75" Sight Radius
- Capacity: 6 + 1
- Length: 7.75" Height: 5"
- Empty Weight: 36 oz.

This is the Schuetzen Pistol Works compact model. The Enforcer has all of the standard features of the Matchmaster, but adds a bushingless bull barrel and a computer-designed recoil system. The heart of this pistol is its advanced triplex counterwound self contained spring recoil system. This is a durable, reliable, quick cycling, compact, yet serious gun. Carry the power of 45 caliber ammunition with you.

The Cohort

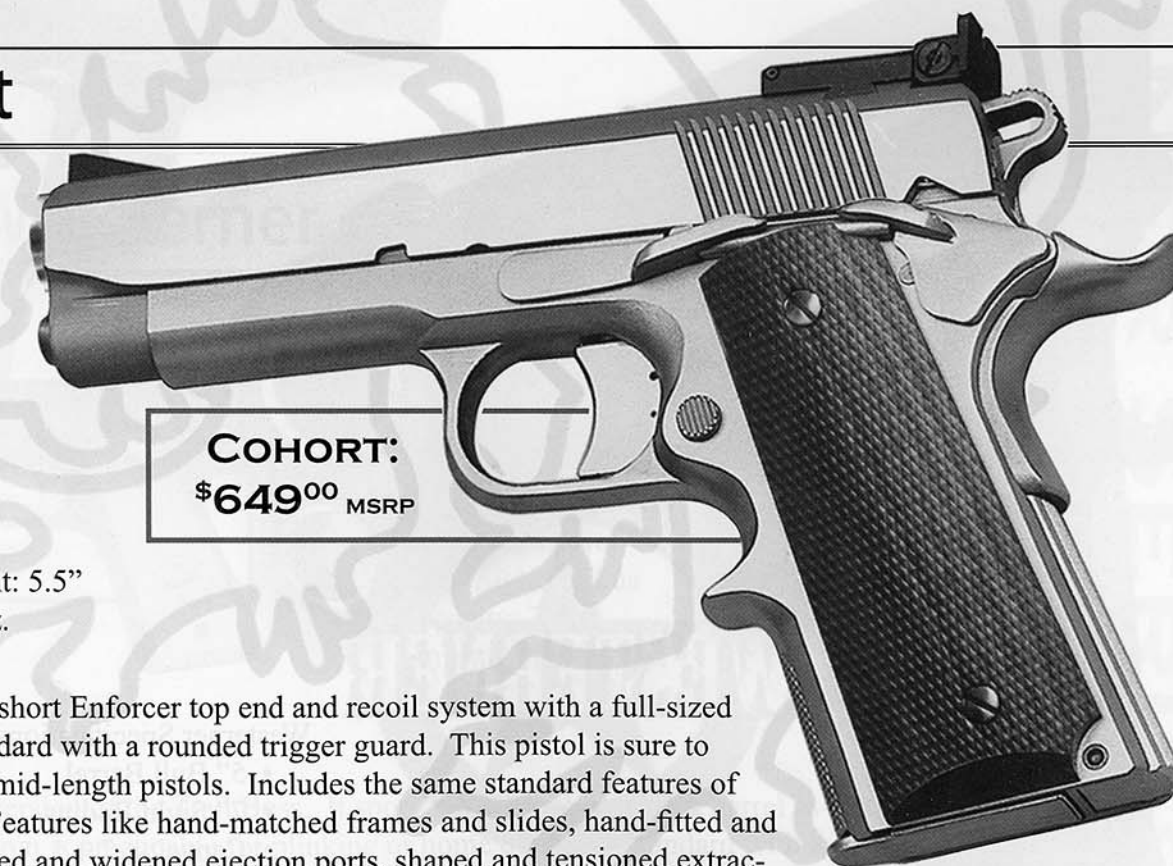

COHORT:
\$649⁰⁰ MSRP

Cohort Specifications:

- 4" Bull Barrel
- 5.75" Sight Radius
- Capacity: 7 + 1
- Length: 7.75" Height: 5.5"
- Empty Weight: 38 oz.

The Cohort combines the short Enforcer top end and recoil system with a full-sized Matchmaster frame. Standard with a rounded trigger guard. This pistol is sure to fit any quality holster for mid-length pistols. Includes the same standard features of the Matchmaster series. Features like hand-matched frames and slides, hand-fitted and headspaced barrels, lowered and widened ejection ports, shaped and tensioned extractors, fully adjustable rear sights, and smooth laser etched walnut grips.

The Westerner

Classic appearance, cowboy style, and modern technology make the Westerner 1911 pistol. The slide and frame are colored to a stunning finish using a method called color case hardening.

Though color case hardening does more than add a colored finish to the pistol. The process is a heat treatment that strengthens the steel and adds a protective casing finish.

Not just beautiful, these handguns are extremely reliable, and will almost never wear. Each pistol is hand fitted, color case hardened, and then re-assembled by hand fitting again. The entire production process leads to surprising capabilities of accuracy. *The Westerner Series are uncompromising works of art.*

Get the looks you deserve the next time you take this pistol to a show, or show it off at the shooting ally. Though some of the Olympic Arms and Schuetzen Pistol Works customers keep their Westerner series pistol for display, we recommend that you enjoy as a pistol.



WESTERNER:
\$695⁰⁰ MSRP

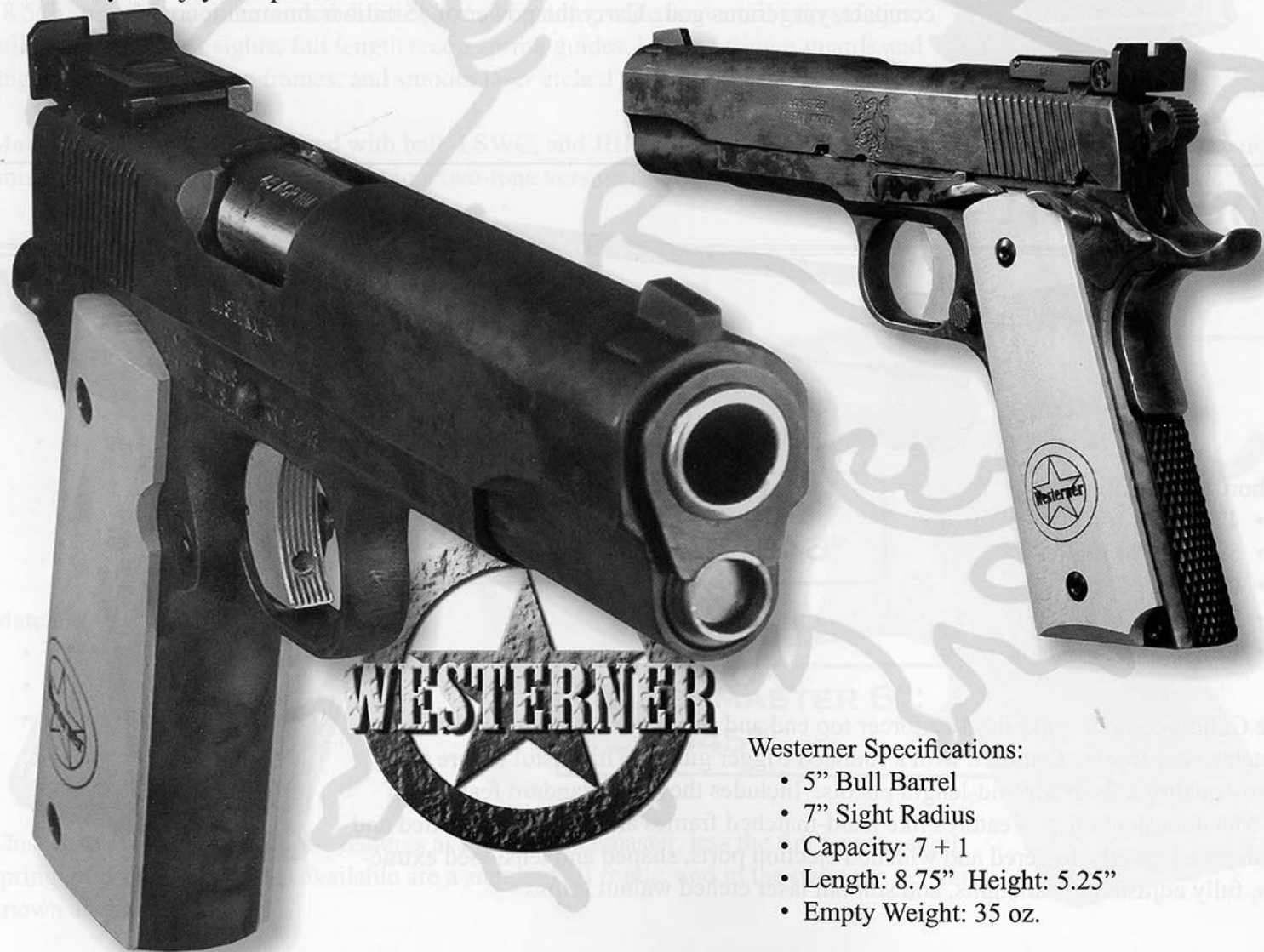

Westerner Specifications:

- 5" Bull Barrel
- 7" Sight Radius
- Capacity: 7 + 1
- Length: 8.75" Height: 5.25"
- Empty Weight: 35 oz.

Building from the great success of the Westerner pistol introduced in 2003, Olympic Arms has decided to expand it's line of true color case hardened 1911 offerings by adding two new models. The truly awe inspiring colors of the color case harden process are lost in this black and white print. Color case harden is an old-fashioned method with side effects of vibrant blues, violets, crimsons, and patinas.

Trail Boss Westerner



TRAIL BOSS:
\$799⁰⁰ MSRP

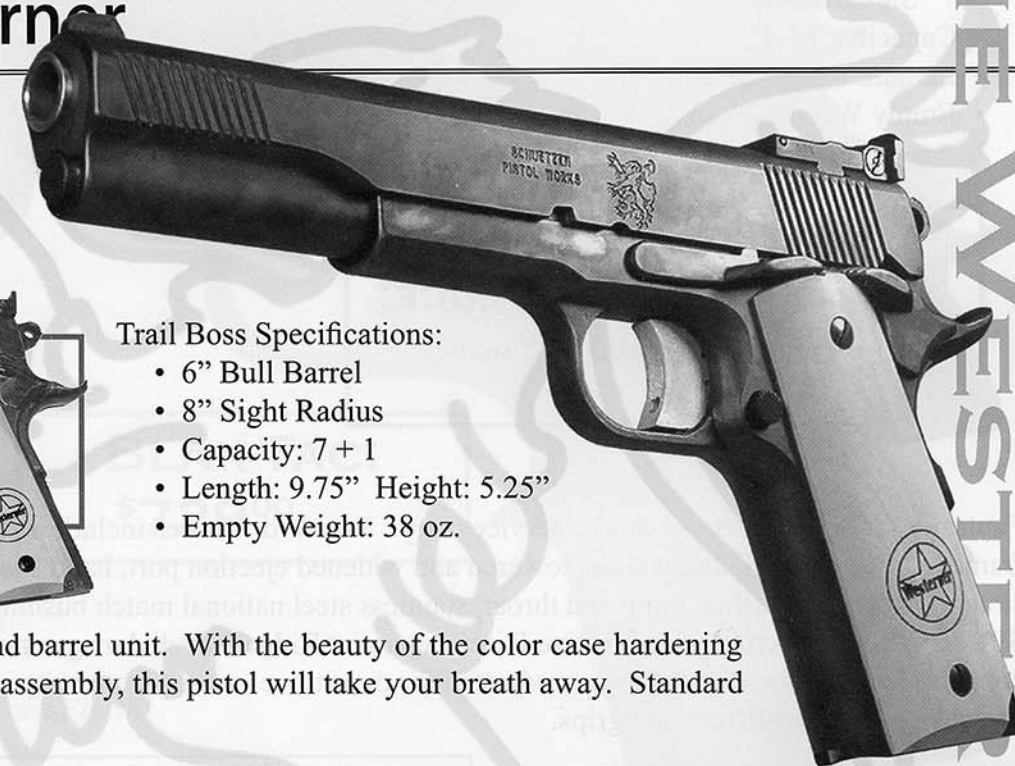

Trail Boss Specifications:

- 6" Bull Barrel
- 8" Sight Radius
- Capacity: 7 + 1
- Length: 9.75" Height: 5.25"
- Empty Weight: 38 oz.

The Trail Boss sports a six inch slide and barrel unit. With the beauty of the color case hardening and add on the extra length of the slide assembly, this pistol will take your breath away. Standard with laser engraved grips.

Constable Westerner

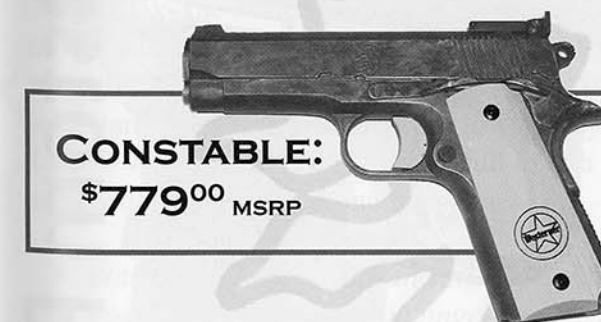

CONSTABLE:
\$779⁰⁰ MSRP

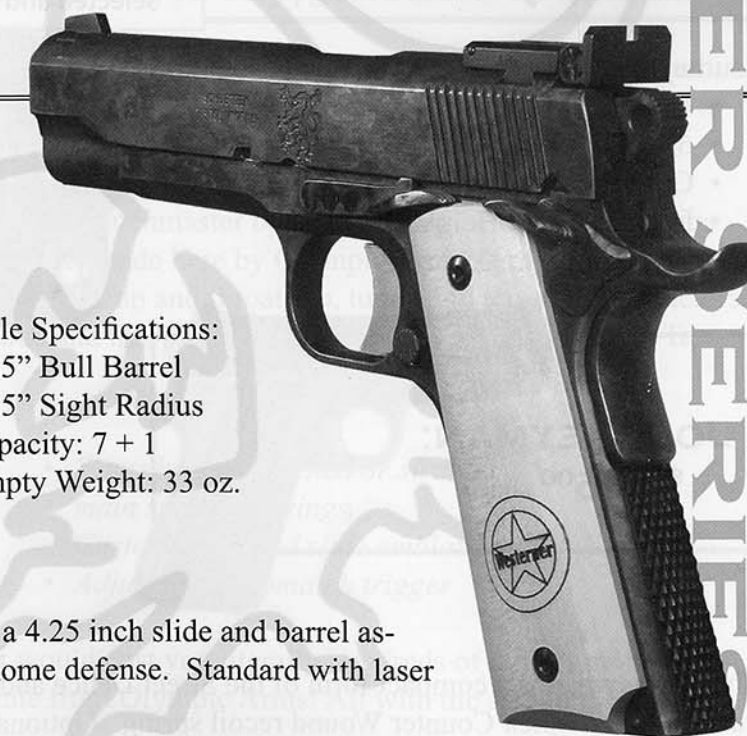

Constable Specifications:

- 4.25" Bull Barrel
- 6.25" Sight Radius
- Capacity: 7 + 1
- Empty Weight: 33 oz.

The Cohort is a compact version of the Trail Boss. It sports a 4.25 inch slide and barrel assembly. This handy handgun is practicable for plinking or home defense. Standard with laser engraved grips.

Schuetzen Pistol Works Custom Pistols

Street Deuce

Street Deuce Specifications:

- 5.2" Bull Barrel
- 7" Sight Radius
- Capacity: 7 + 1
- Length: 8.75" Height: 5.5"
- Empty Weight: 38 oz.



Fantastic for daily street use or as a service carry. Standard features include a stainless steel frame, carbon steel Maxhard slide, lowered and widened ejection port, hand shaped and tensioned extractor, polished ramp and throat, stainless steel national match bushingless bull barrel, SPW Hi-Ride beavertail with Positive Disengagement Ridge, beveled magazine well, hand matched sear and commander hammer, custom trigger adjusted for over-travel, raised front strap, extended thumb safety, double diamond checkered Rosewood grips.

The Street Deuce and the Journeyman are both custom made pistols from the Schuetzen Pistol Works custom shop. Each part is hand selected and fitted by expert pistolsmiths.

Journeyman

Journeyman Specifications:

- 4" Bull Barrel
- 6" Sight Radius
- Capacity: 7 + 1
- Length: 7.75" Height: 5.5"
- Empty Weight: 35 oz.

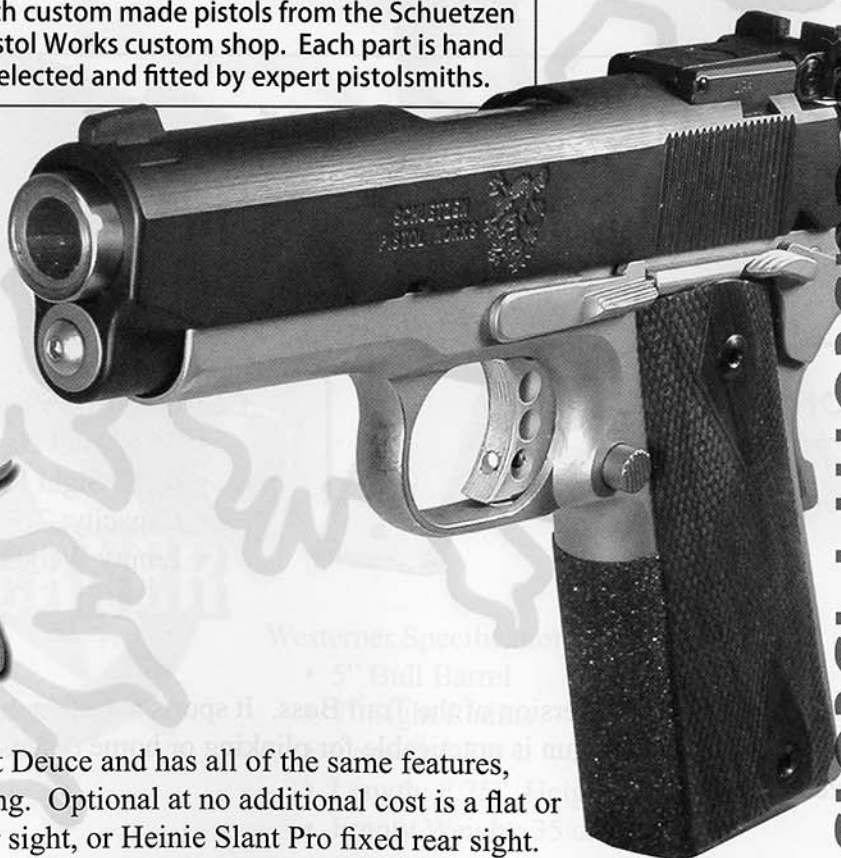

The Journeyman is a compact form of the Street Deuce and has all of the same features, but adds our Triplex Counter Wound recoil spring. Optional at no additional cost is a flat or arched mainspring housing, LPA adjustable rear sight, or Heinie Slant Pro fixed rear sight.

Blak-Tac Matchmaster

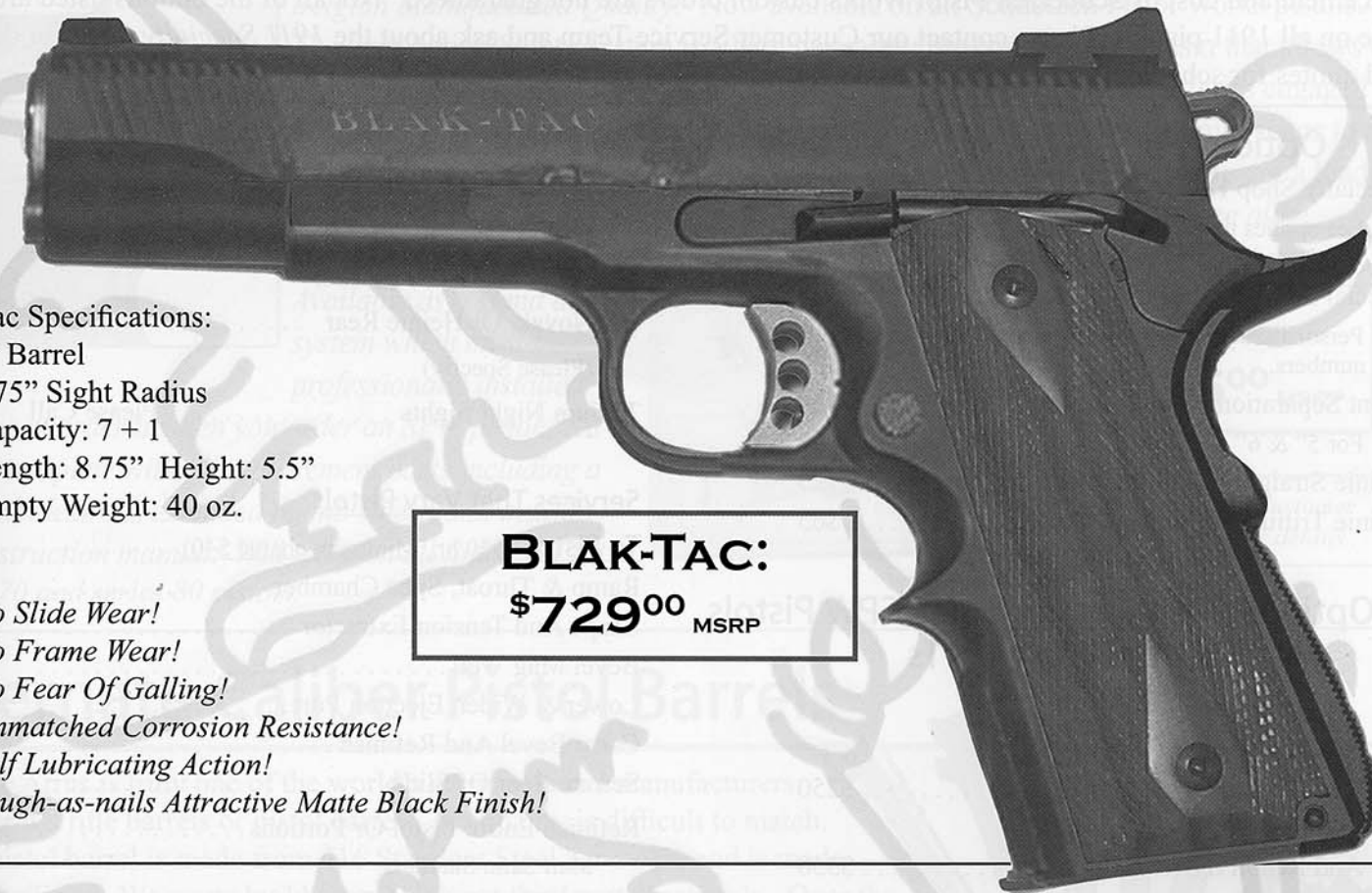

Blak-Tac Specifications:

- 5" Barrel
- 6.75" Sight Radius
- Capacity: 7 + 1
- Length: 8.75" Height: 5.5"
- Empty Weight: 40 oz.

BLAK-TAC:
\$729⁰⁰ MSRP

- *No Slide Wear!*
- *No Frame Wear!*
- *No Fear Of Galling!*
- *Unmatched Corrosion Resistance!*
- *Self Lubricating Action!*
- *Tough-as-nails Attractive Matte Black Finish!*

The Olympic Arms Blak-Tac process has been used as a standard on all of the bolt carriers produced by Olympic Arms for a few years now. The Blak-Tac Matchmaster was introduced in 2003, but was upgraded in 2004 for appearance and configuration in order to fit the Tactical implications of its name.

The frames and slides of each Blak-Tac Matchmaster are hand-fitted and the pistols are fully assembled, then and only then do we proceed with the Blak-Tac processing. Why? Because once we have treated the frames and slides to the Blak-Tac process, they become so hard, that fitting is no longer an option!

The Blak-Tac Matchmaster is an awesome piece of mechanical functional reliability with unmatched longevity, mixed with a beautiful appearance. Designed around the standard Matchmaster by Olympic Arms, this pistol begins with all the same features such as a 416 true National Match barrel made here by Olympic Arms. It is also standard with items such as a widened and lowered ejection port, complete ramp and throat job, tuned and tensioned extractors, 18.5 lb Wolff brand recoil spring, full length recoil spring guide and more. But it is then outfitted with the Blak-Tac standard package which includes:

- *Blak-Tac treated frame and slide*
- *Round trigger guard with finger groove front strap*
- *High-ride Olympic Arms beavertail with PDR*
- *Low Profile combat style sights*
- *Front and rear slide serrations*
- *Your choice of arched or straight main spring housings.*
- *Custom engraved slide emblazoned Blak-Tac*
- *Adjustable automatch trigger*

This is a great deal of 1911 for the money. With features that would cost you literally hundreds of dollars more elsewhere, plus the Blak-Tac treated frame and slide only available from Olympic Arms! All with the standard Olympic Arms Lifetime Warranty.

1911 Pistol Parts

SA46 Extended Thumb Safety. Choose (A) Black, or (B) Stainless.  **\$10⁵⁰**

SA50 Ambidextrous Safety. Extended. Choose (A) Black, or (B) Stainless.  **\$19⁹⁵**

SA55 Commander Hammer. Choose (A) Black, or (B) Stainless.  **\$12⁹⁵**

SA52 5" Guide Rod.  **\$12⁵⁰**

SA53 Extended Magazine Catch. 1/10" longer than standard.  **\$9⁵⁰**

MM01 Stainless Magazine. For Matchmaster, holds 7 rounds.  **\$24⁰⁰**

EEM01 Stainless Magazine. For Enforcer, holds 6 rounds.  **\$24⁰⁰**

C4551 Large Mag Catch Button. Choose (A) Black, or (B) Stainless.  **\$13⁹⁵**

SA47 Extended Slide Stop. Choose (A) Black, or (B) Stainless.  **\$10⁵⁰**

SA48 SPW Hi-Ride Beavertail. With Positive Disconnect Ridge. Stainless only.  **\$16⁰⁰**

SA49 Safari Beavertail Grip Safety. Choose (A) Black, or (B) Stainless.  **\$8⁵⁰**

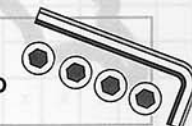
AS1 Allen Head Grip Screws. Includes wrench. Choose from (A) Black, or (B) Stainless.  AS1-A **\$4⁵⁰**
AS1-B **\$5⁵⁰**

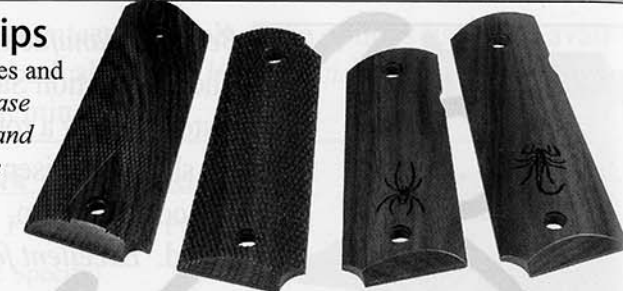
Side Grips Various sizes and styles. Please verify size and style before ordering. 

\$25⁰⁰ PHB2 Smooth finish wood with laser etched black widow. Fits Olympic Arms Enforcer sized pistol grips.

\$25⁰⁰ PHB3 Smooth finish wood with laser etched scorpion. Fits Olympic Arms Matchmaster sized pistol grips.

\$24⁰⁰ EB-2 Double Diamond Checkered Exotic Wood. Designed exclusively for Olympic Arms

\$13²⁵ EB Checkered Side Grip.

Mainspring Housings. Not shown. Choose from the following:

\$25⁰⁰ C4536 Aluminum mainspring housing for Gov't, Matchmaster.

\$40⁰⁰ C4536B Aluminum mainspring housing for Enforcer, complete.

\$35⁰⁰ C56SA Smith & Alexander checkered mainspring housing. Checkered to 20LPI. Specify arched or flat.

LPA Adjustable Sights Serrated, black. 
LPA-1A White, 3-dot. **\$42⁰⁰**
LPA-2A Adjustable sight. **\$42⁰⁰**
LPA-3A Front sight. **\$6⁵⁰**

C4533A Standard Aluminum 1911 Trigger.  **\$9⁹⁵**

C4533V Adjustable Auto-Match 1911 Trigger. Stainless steel, complete, includes hex head wrench. **\$10⁵⁰**

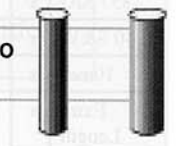
HHP-1 Hardened Hammer And Sear Pins. Heat-stress-relieved and ground to maximum diameter specified on 1911 specifications for precise fit.  **\$6⁵⁰**

1911 Slides

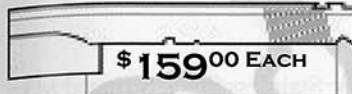
 **\$159⁰⁰ EACH**

 **\$169⁰⁰ EACH**

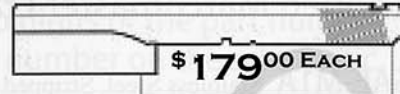
 **\$179⁰⁰ EACH**

Matchmaster 5" Slide Round top, available in stainless steel or carbon steel.

Enforcer/Cohort 4" Slide Available in stainless steel or carbon steel. Not available with front serrations

Matchmaster 6" Slide Available in stainless steel or carbon steel.

SAS-1A 5" Stainless Steel slide.
SAS-1B 5" Carbon Steel Slide

SAS-2A 4" Stainless Steel slide.
SAS-2B 4" Carbon Steel Slide

SAS-6A 6" Stainless Steel slide.
SAS-6B 6" Carbon Steel Slide

Slide Features:

- LPA rear sight cut as standard on all slides.
- Front sight dovetail cut standard at .320" x 60 on all slides.
- Custom sight cuts or no sight cuts available with special order.
- Front serrations available on all 5' and 6" slides.
- All special orders are produced the Schuetzen Pistol Works Specialty Shop.

Please specify Stainless Steel or Carbon Steel when ordering slides, top ends, or frames.

1911 Complete Top Ends

Complete Top Ends These units are complete with all parts but unassembled. Available in various lengths and configurations. Parts included are bushing, slide stop, slide, national match barrel, one-piece recoil assembly, LPA adjustable sight set, firing pin stop, firing pin, firing pin spring, and extractor.

Code	Description	Cost
SA100-5A	5" Slide Assembly, Stainless Steel	\$299 ⁰⁰
SA100-5B	5" Slide Assembly, Carbon Steel	\$299 ⁰⁰
SA100-4A	Enforcer Style Slide Assembly, Stainless Steel	\$395 ⁰⁰
SA100-4B	Enforcer Style Slide Assembly, Carbon Steel	\$395 ⁰⁰
SA100-6A	6" Slide Assembly, Stainless Steel	\$319 ⁰⁰
SA100-6B	6" Slide Assembly, Carbon Steel	\$319 ⁰⁰
SA100-5DA	5" D-Type Slide Assembly, Stainless Steel	\$349 ⁰⁰
SA100-5DB	5" D-Type Slide Assembly, Stainless Steel	\$349 ⁰⁰
+P	Add Parkerized Carbon Steel Slide Assembly	\$25 ⁰⁰



National Match Bull Barrels

These barrels require fitting. Available through Schuetzen Pistol Works Specialty Shop only.

 **\$125⁰⁰ EACH**
Enforcer/Cohort/Journeyman 4.25" Barrel
Available in .45 ACP caliber only.

 **\$125⁰⁰ EACH**
Street Deuce 5" Barrel
Modified cone on a bull barrel. Available in .45 ACP caliber only.

Code	Description	Added Cost
+KS	Slide Insert Kit. All parts for 5" 1911 top end less the slide itself.	\$148 ⁰⁰
+KSE	Slide Insert Kit. All parts for 4" 1911 top end less the slide itself.	\$198 ⁰⁰
+P	Parkerized Frame	\$25 ⁰⁰

1911 Frames

1911 Small Parts View / List

Stripped Matchmaster Frames Model 1911 Series 70.

SAF-M1A Stainless Steel, Stripped M1
SAF-M1B Carbon Steel, Stripped M1

SAF-M2A Stainless Steel, Stripped M2
SAF-M2B Carbon Steel, Stripped M2

SAF-M3A Stainless Steel, Stripped M3
SAF-M3B Carbon Steel, Stripped M3

M1.
 Hooked trigger guard & finger groove front strap.

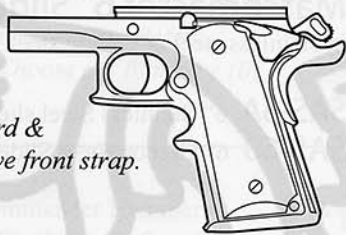

M2.
 Square trigger guard & finger groove front strap.

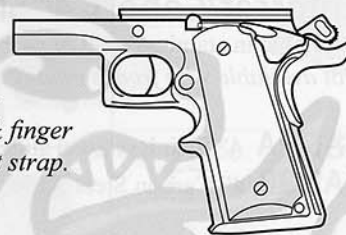

M3.
 Round trigger guard & finger groove front strap.

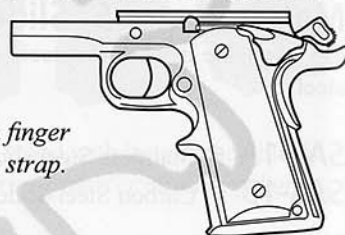

CRF1A Stainless Steel, Stripped CRF1
CRF1B Carbon Steel, Stripped CRF1

CRF2 Stainless Steel, Stripped CRF2
CRF2B Carbon Steel, Stripped CRF2

CRF1. Standard GI type frame with round trigger guard and straight front strap.



CRF2. Standard GI type frame with square trigger guard and straight front strap.

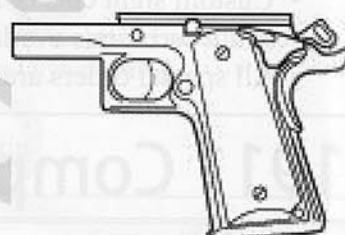

Stripped Enforcer Frames Model 1911 Series 70.

SAF-E1A Stainless Steel, Stripped E1
SAF-E1B Carbon Steel, Stripped E1

SAF-E2A Stainless Steel, Stripped E2
SAF-E2B Carbon Steel, Stripped E2

SAF-E3A Stainless Steel, Stripped E3
SAF-E3B Carbon Steel, Stripped E3

E1.
 Hooked trigger guard & finger groove front strap.

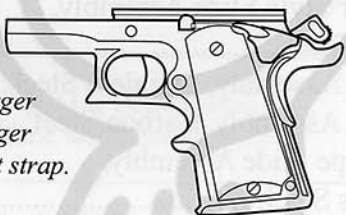

E1.
 Square trigger guard & finger groove front strap.

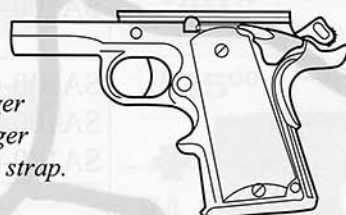

E1.
 Round trigger guard & finger groove front strap.

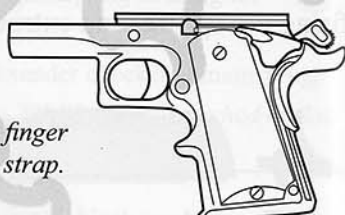

SAF-E4A Stainless Steel, Stripped E4
SAF-E4B Carbon Steel, Stripped E4

SAF-E5A Stainless Steel, Stripped E5
SAF-E5B Carbon Steel, Stripped E5

E1. Square trigger guard & straight front strap.

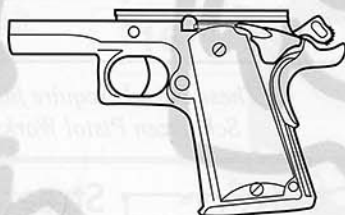

E1. Round trigger guard & straight front strap.

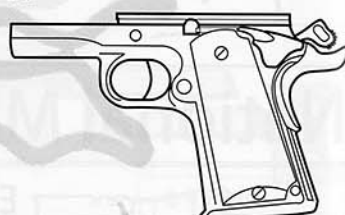

Code	Description	Added Cost
+KF	Insert Kit. All parts for 1911 frame less the frame itself.	\$148 ⁰⁰
+P	Parkerized Frame	\$35 ⁰⁰
+L	Loaded Frame. Installation of an insert kit onto a frame.	\$35 ⁰⁰

EVERY FRAME:
\$109⁰⁰
 EACH MSRP

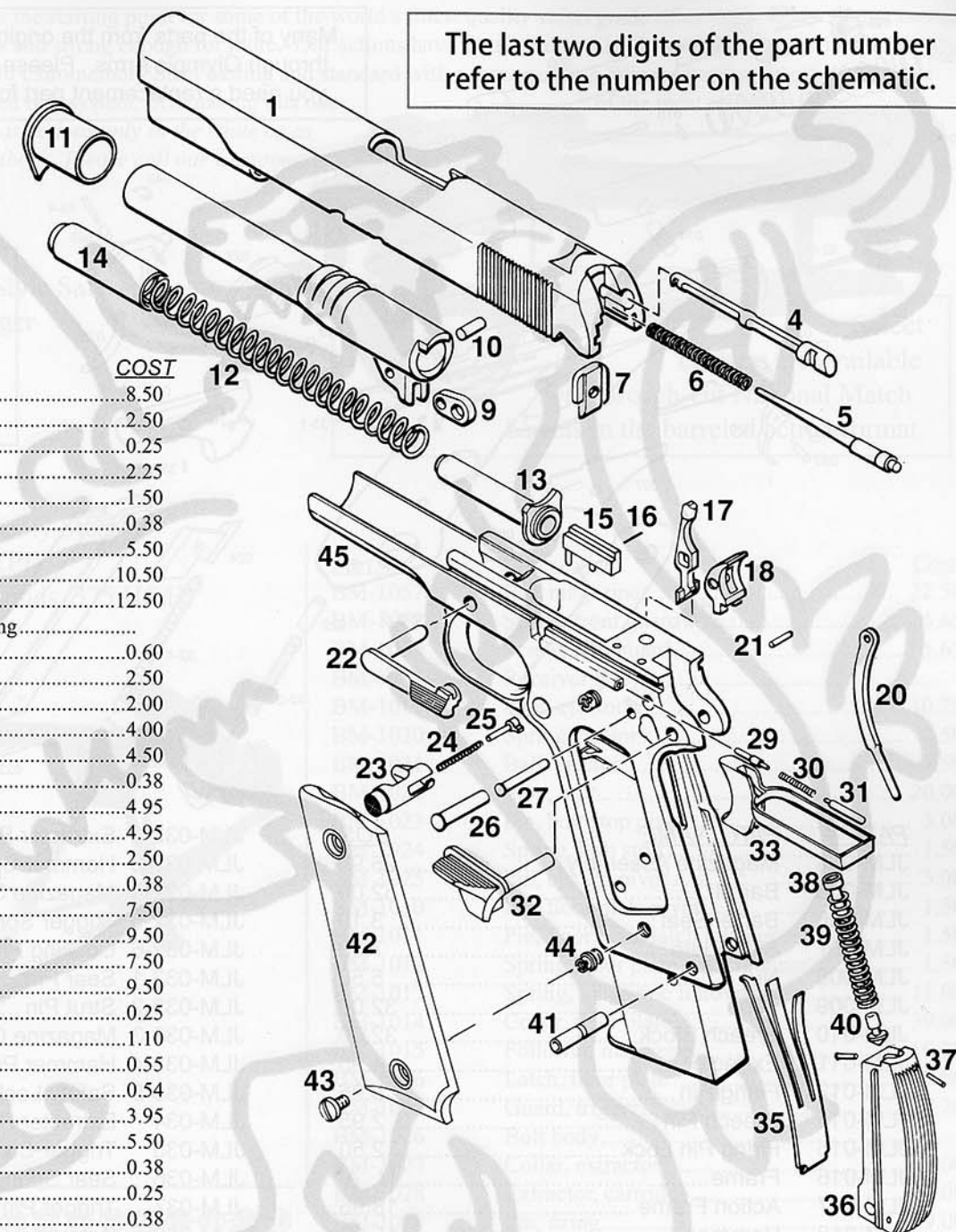

The last two digits of the part number refer to the number on the schematic.

If a price is not specified, or you cannot find the part you need, please call our Customer Service Team for assistance.

PART #	PART NAME	COST
C4504	Extractor.....	8.50
C4505	Firing Pin.....	2.50
C4506	Firing Pin Spring.....	0.25
C4507	Firing Pin Stop.....	2.25
C4509	Barrel Link - Black.....	1.50
C4510	Barrel Link Pin.....	0.38
C4511A	Barrel Bushing - Black.....	5.50
C4511B	National Match Bushing.....	10.50
C4511C	Barrel Bushing - Stainless.....	12.50
C4511D	Stainless National Match Bushing.....	
C4512	Recoil Spring.....	0.60
C4513	Recoil Spring Guide - Gov't.....	2.50
C4514A	Recoil Spring Cap - Black.....	2.00
C4514B	Recoil Spring Cap - Stainless.....	4.00
C4515	Ejector - Gov't.....	4.50
C4516	Ejector Pin.....	0.38
C4517	Disconnecter.....	4.95
C4518	Sear.....	4.95
C4520	Hammer Strut.....	2.50
C4521	Hammer Strut Pin.....	0.38
C4522A	Slide Stop - Gov't.....	7.50
C4522B	Slide Stop Stainless/Gov't.....	9.50
C4523A	Magazine Catch - Black.....	7.50
C4523B	Magazine Catch - Stainless.....	9.50
C4524	Magazine Catch Spring.....	0.25
C4525	Magazine Catch Lock.....	1.10
C4526	Hammer Pin.....	0.55
C4527	Sear Pin.....	0.54
C4528A	Plunger Tube - Black.....	3.95
C4528B	Plunger Tube - Stainless.....	5.50
C4529	Slide Stop Plunger.....	0.38
C4530	Plunger Spring.....	0.25
C4531	Safety Plunger.....	0.38
C4532A	Thumb Safety - Black.....	7.95
C4532B	Thumb Safety - Stainless.....	10.95
C4533A	Aluminum Trigger.....	6.95
C4533V	Adjustable Match Trigger.....	10.50
C4535	Sear Spring.....	1.75
C4536A	Mainspring Housing Flat - Black.....	12.50
C4537	Mainspring Cap Pin.....	0.38
C4538	Mainspring Cap.....	0.35
C4539	Mainspring.....	0.25
C4540	Mainspring Retainer.....	0.38
C4541	Mainspring Housing Retainer Pin.....	0.38
C4543	Grip Screw - Black.....	0.38
C4543A	Grip Screw - Stainless.....	0.85
C4544	Grip Screw Escutcheon - Black.....	0.38
C4544A	Grip Screw Escutcheon - Stainless.....	0.85

Parts Kit. These kits include all of the parts necessary to finish a stripped slide or frame less the magazine, grips, frame, or slide. Please specify stainless steel or black.

Frame Kit.....\$148⁰⁰
 Slide Kit.....\$148⁰⁰

Whitney Wolverine Parts View / List

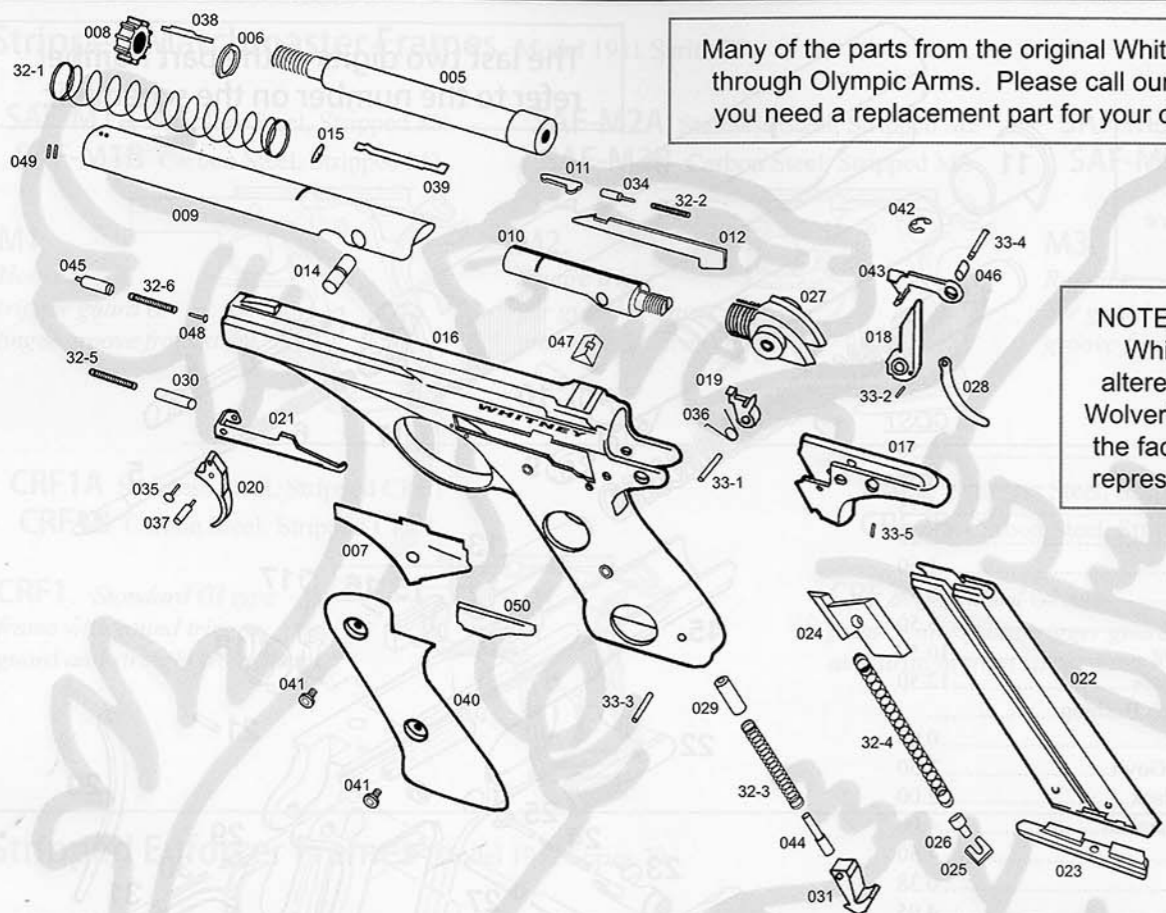

Many of the parts from the original Whitney Wolverine are available through Olympic Arms. Please call our Customer Service Team if you need a replacement part for your original Whitney Wolverine.

NOTE: The design of the current Whitney Wolverine is slightly altered from the original Whitney Wolverine. The parts schematic on the facing page will not accurately represent parts for original pistols.

If a price is not specified, or you cannot find the part you need, please call our Customer Service Team for assistance.

PART #	PART NAME	COST	PART #	PART NAME	COST
JLM-004	Magazine Assembly	26.95	JLM-032-2	Extractor Spring	1.25
JLM-005	Barrel	52.00	JLM-032-3	Hammer Spring	1.25
JLM-006	Barrel Seat	3.10	JLM-032-4	Magazine Spring	1.25
JLM-007	Side Plate	7.50	JLM-032-5	Trigger Spring	1.25
JLM-008	Nut	5.50	JLM-032-6	Cocking Plunger Spring	1.25
JLM-009	Tube	32.00	JLM-033-1	Sear Pin	1.25
JLM-010	Breech Block	32.00	JLM-033-2	Strut Pin	1.25
JLM-011	Extractor	4.95	JLM-033-3	Magazine Catch Pin	1.25
JLM-012	Firing Pin	8.95	JLM-033-4	Hammer Pin	1.25
JLM-014	Breech Pin	2.95	JLM-033-5	Safety Lock Pin	1.25
JLM-015	Firing Pin Lock	2.50	JLM-034	Extractor Plunger	1.25
JLM-016	Frame	N.A.	JLM-035	Trigger Connector	1.25
JLM-017	Action Frame	18.95	JLM-036	Sear Spring	3.25
JLM-018	Hammer	15.95	JLM-037	Trigger Pin	1.25
JLM-019	Sear	6.50	JLM-038	Barrel Key	2.50
JLM-020	Trigger	8.95	JLM-039	Ejector	5.25
JLM-021	Sear Bar	10.95	JLM-040	Pistol Grips	22.50
JLM-023	Magazine Bottom		JLM-041	Screw, Pistol Grip & Side Plate	2.25
JLM-024	Magazine Follower		JLM-042	'C' Clip - Hammer Pin	
JLM-025	Magazine Bottom Lock		JLM-043	Magazine Disconnect	4.75
JLM-026	Magazine Insert		JLM-044	Hammer Spring Seat	1.50
JLM-027	Cocking Piece		JLM-045	Barrel Locking Plunger	
JLM-028	Strut	2.95	JLM-046	Hammer Pin Sleeve	
JLM-029	Hmr Sprng Plunger	2.10	JLM-047	Rear Sight	4.50
JLM-030	Trigger Spring Plunger	2.10	JLM-048	Spring Seat Pin	1.25
JLM-031	Magazine Catch	4.95	JLM-049	Barrel Index Pin (2)	
JLM-032-1	Mainspring	5.95	JLM-050	Safety	7.95

Ultramag Barreled Actions And Custom Rifles

BBK-01. The BBK Ultramag action is the starting point for some of the world's finest quality safari grade rifles made today. Large enough to chamber up to the .505 Gibbs cartridges and strong enough for more. Our actions have been used to take down dangerous game all over the world. Constructed from high quality 4140 Chromemoly Steel casting and standard with a three position Winchester® style safety, positive claw extractors, and a controlled round feed bolt system. All making this one of the most reliable and safest actions every made. Available as actions only in the white or as assembled barreled actions in various calibers. Please call our Customer Service Team for details.

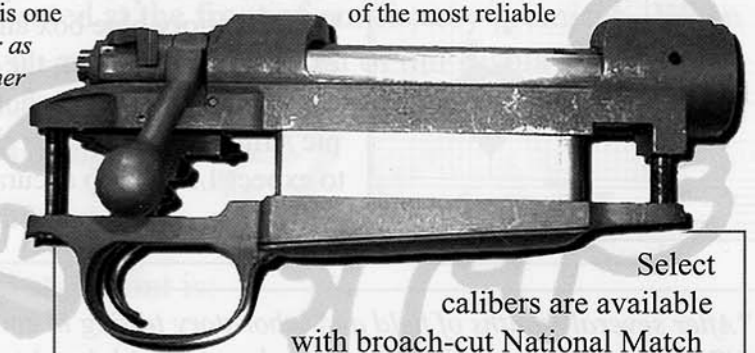

Select calibers are available with broach-cut National Match barrels in the barreled action format.

Ultramag Features:

- Three Position Winchester® Style Safety
- Fully Adjustable Timney Trigger
- Mauser Claw Extractor
- C Internal Ring
- Controlled Round Feeding
- Uncut Double Square Bridge
- Bolt Face Cut To .532"
- Receiver From 4140 Chromemoly Steel
- Barrel Thread Of 1.10" x 12 TPI
- Magazine Capacity Of Six Rounds .375 H&H
- Magazine Length Of 3.85"

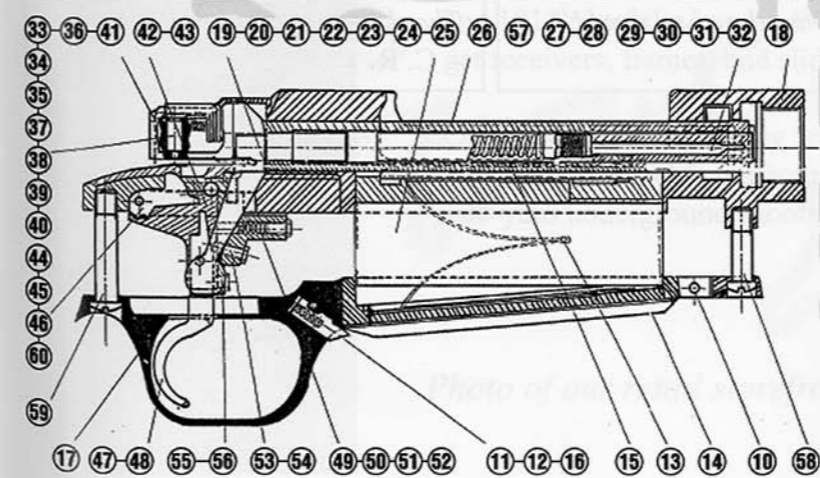
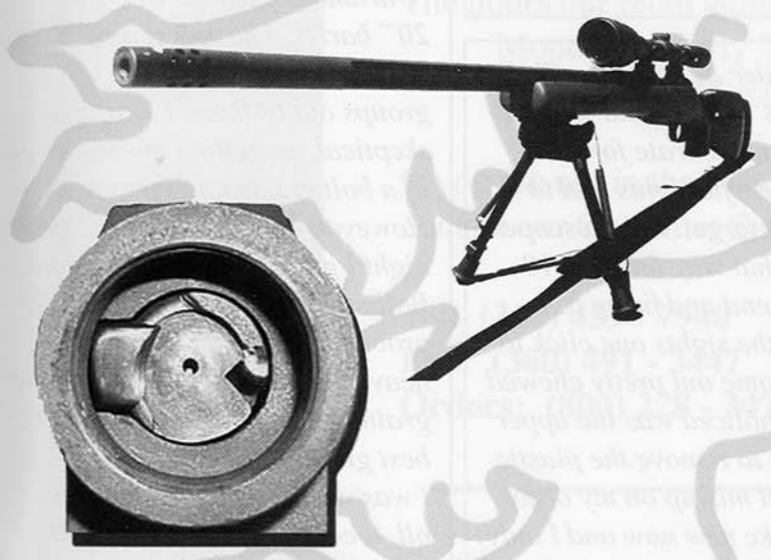

Part #	Description	Cost
BM-1057	Box magazine	22.50
BM-1058	Screw, front guard	5.65
BM-1059	Screw, rear guard	5.65
BM-1018	Receiver body	
BM-1019	Arm, ejector	10.25
BM-1020	Spring ejector	1.50
BM-1021	Ball, ejector	1.50
BM-1022	Stop, bolt	20.00
BM-1023	Pin, bolt stop pivot	3.00
BM-1024	Spring, bolt stop	1.50
BM-1025	Pin, ejector pivot	3.00
BM-1010	Pin, floor plate pivot	1.50
BM-1011	Pin, floor plate latch retainer	1.50
BM-1012	Spring, floor plate latch retainer	1.50
BM-1013	Spring, magazine follower	11.00
BM-1014	Cover, floor plate	39.00
BM-1015	Follower, magazine	10.20
BM-1016	Latch, floor plate	7.80
BM-1017	Guard, trigger	58.20
BM-1026	Bolt body	
BM-1027	Collar, extractor	9.00
BM-1028	Extractor, cartridge	27.00
BM-1029	Pin, firing	39.00
BM-1030	Spring, firing pin	9.00
BM-1031	Locking collar, firing pin	5.40
BM-1032	Nut, knurled firing pin	7.80
BM-1033	Shroud, striker	51.00
BM-1034	Cocking piece, striker	15.00
BM-1035	Lever, safety	15.00
BM-1036	Pin, cocking piece to firing pin	1.10
BM-1037	Screw, safety lever to shroud	1.20
BM-1038	Spring, safety lever	1.50
BM-1039	Plunger, safety lever	5.40
BM-1040	Ball, shroud detent	5.40
BM-1041	Spring, shroud detent	1.55
BM-1048	Trigger, Timney	54.00
BM-1102	Pin, trigger to receiver	3.00

Testimonials To Olympic Arms

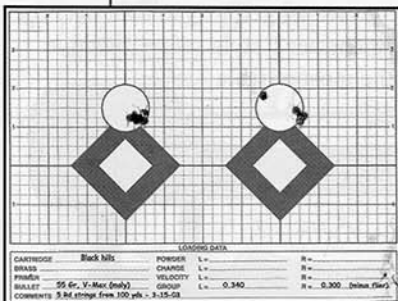

These targets were shot by an Olympic Arms customer at 100 yards using Black Hills 55 grain V-Max factory blue box ammunition. With the exception of one flyer, the Olympic Arms K16 rifle made these two 10 shot 1/2" groups. Olympic Arms owners all over the world have come to expect 1/2" group accuracy, most of the time right out of the box.

"After several months of field and laboratory testing in cooperation with both US forces domestic and overseas, and testing with local troops in the harsh, hot, dusty, desert conditions in Kuwait, Iraq, and the United Arab Emirates we have arrived at the conclusion that FP-10 has performed flawlessly for us, and at every stage of the thorough evaluation process FP-10's performance was impressive. In the desert, the 'boundary film' technology allowed weapons to be fired 'dry' preventing sand and dust adherence, whilst still providing a 'boundary film' perservative coating to inhibit corrosion."

- Brian Goldie, Cheif Executive Officer, Cleenbore Ltd., October 25, 2003

"I ordered a T-2 upper receiver last week to update an older A-1 receiver CAR-15 kit I had purchased from PAC West Arms over 10 years ago. The kit was all PAC West except your barrel. Your barrel had always been accurate for a 10 1/2 inch CAR barrel set up but it had a sight problem. The rifle sights had to be adjusted all the way to the right in order for it to be on target. I put a scope on this less than mil-spec A-1 upper receiver and shot it that way for over 10 years. Now, after installing your upper receiver this weekend and firing it, I was amazed how accurate it is now! I only had to adjust the sights one click to the right and it is was dead on target! My brass used to come out pretty chewed up and now that problem is gone as well! Another item I noticed was the upper to lower receiver fit is much tighter now. This allowed me to remove the plastic spacer I had to use to take the slop out! There was a small mix up on my order but your folks fixed that with one phone call. My rifle is like new now and I only wished I had updated it sooner! When you say mil-spec tolerances you mean mil-spec tolerances! I am a very satisfied customer, keep up the good work!"

- K. J. P., SMSgt USAF (retired)

"My first 'black rifle' was a PCR4 with a 20" stainless ultramatch barrel. I don't consider myself to be a great shot, but this gun makes me look good!"

- K.C.

"I just received my FIRSH and installed it last night....the mounting system is incredible... barrel torque and final spin-on plus the two set screws went so cleanly!!! Thank you for this excellent product."

- T.W.

"I recently purchased your 'Ultramatch' AR-15 with the 20" barrel. The guy selling me the rifle said they got 1/4" groups out of them. I was pretty skeptical, as getting quarters out of a bolt gun is tough enough. However, he was right! The first night I got a .260 with 40-grain Ballistic tips. Knowing it would probably shoot better with the heavier bullets, I tried some 55-grain Ballistic tips and shot the best group of my life, a .074".

I was witnessed by Kevin Huxoll, a correctional officer at the Washington State Penitentiary. Thanks for a great gun!"

- C. R.



Washington residents, visitors, and military personnel are welcome to visit our full service retail storefront.

Our retail storefront is located at the front of our factory premises. When you come in for a visit you can see and hold all of our display rifles, get knowledgeable assistance from our Customer Service Team, place orders, get upgrades, and bring in repairs.

The address for the retail storefront is:

**624 Old Pacific Hwy SE
Olympia, WA 98513**

Front Interstate-5 (Northbound and Southbound) take exit 116 and drive 2.6 miles south. Look for the big blue building.

The hours our retail storefront is open are:

Monday - Friday 7:30 AM - 4:30 PM PST

**Excluding holidays.*

If you are not in the Puget Sound area of Washington State, you can still contact our Customer Service Team by phone and fax. The numbers are:

Tel: (360) 459 - 7940

Fax: (360) 491 - 3447

Orders: (800) 228 - 3471

At Olympic Arms we manufacture every major component of our AR style rifles and 1911 pistols in house. We even own our own casting house from which we get receivers, frames, and slides.

Our manufacturing facility features state-of-the-art computer controlled CNC machines, a barrel manufacturing shop, black-oxide coating shop, warehouse, a 100-yard underground shooting range, main offices, and our retail storefront.

Photo of our retail storefront in Olympia, WA.

6550

LTF Lightweight Tactical Fluted

OA-93 Carbine w/ Side Folding Stock

22+17 Solution - Conversion System

Constable Westerner

OA-93 - AR Pistol

Whitney Wolverine



Olympic Arms, Inc.
624 Old Pacific Hwy SE
Olympia, WA 98513