

American Spirit Arms, Corp.



2000 Catalog

15001 N. Hayden Rd. Suite 112, Scottsdale, Arizona 85260 www.gunkits.com

Tel: 1-888-486-5487 Fax: 1-480-483-5301

DIGITIZED FOR
YOUR REVIEW AT
WWW.SMALLARMSOFTHEWORLD.COM

saW

ASA Competition Rifles

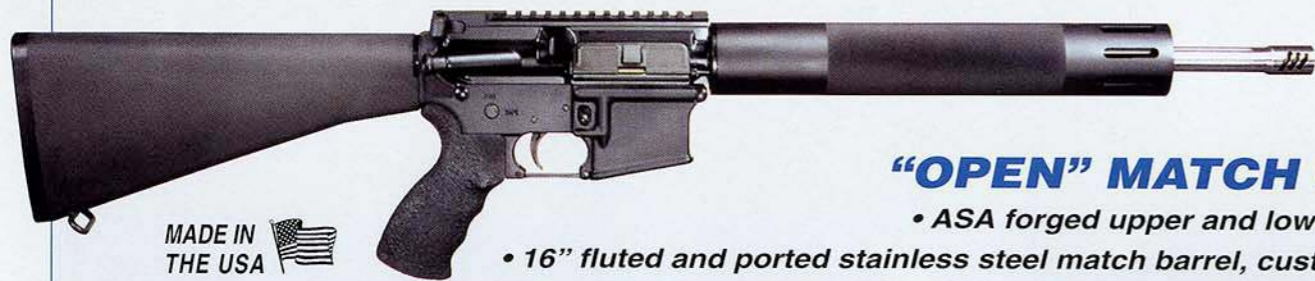

MADE IN THE USA 

"OPEN" MATCH RIFLE

- ASA forged upper and lower receiver
- 16" fluted and ported stainless steel match barrel, custom turned to medium-light weight dimensions - available in either 1:8 or 1:9 twist
- Two stage match trigger, hand tuned to 3 to 3.5 pounds
- Upgraded pistol grip, choice of Ergo grip or Hogue
- Hard chromed plated bolt and carrier
- Individually tested for function and accuracy
- USPSA/IPSC Open class legal

"OPEN" MATCH RIFLE #R-OP001 **\$1,499.95**

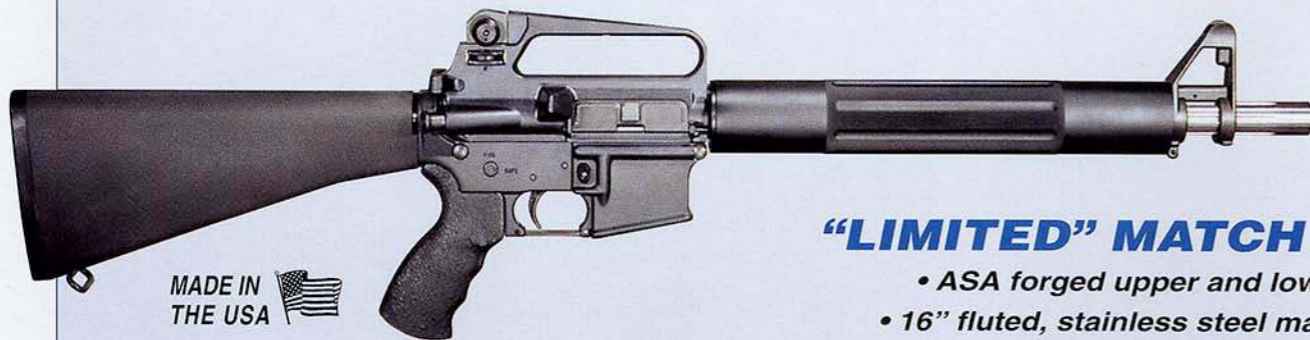

MADE IN THE USA 

"LIMITED" MATCH RIFLE

- ASA forged upper and lower receiver
- 16" fluted, stainless steel match barrel - available in either 1:8 or 1:9 twist
- Two stage match trigger, hand tuned to 3 to 3.5 pounds
- National Match front and rear sights
- Upgraded pistol grip, choice of Ergo grip or Hogue
- Hard chromed plated bolt and carrier
- Individually tested for function and accuracy
- USPSA/IPSC Limited class and SOF legal
- Also available with Flat Top upper receiver and removable carry handle for additional \$125.00

"LIMITED" MATCH RIFLE #R-L002 **\$1,299.95**



MADE IN THE USA 

DCM SERVICE RIFLE

- ASA forged upper and lower receiver
- 20" stainless steel match barrel, 1:8 twist - full 1.050" diameter underneath the handguards for maximum weight and stability
- Two stage match trigger, hand tuned to stay within service rifle rules
- DCM/Service rifle free float handguard system
- National Match front and rear sights
- Hard chromed plated bolt and carrier
- Individually tested for function and accuracy

DCM SERVICE RIFLE #R-DCM01 **\$1,299.95**

ASA 24" Bull Barrel Rifle



MADE IN THE USA 

Scope, base and rings sold separately

COMPLETE 24" BULL BARREL FLATTOP RIFLE FEATURING:

- ASA forged lower receiver
- ASA forged aluminum flattop upper receiver
- Wilson 24" stainless steel 1:8 or 1:9 twist bull barrel
- Precision hard chrome bolt carrier
- Free float aluminum handguard

ASA 24" BULL BARREL FLATTOP RIFLE #R-2400FT **\$949.95**

ASA 24" Bull Barrel A2 Rifle



MADE IN THE USA 

COMPLETE 24" BULL BARREL A2 RIFLE FEATURING:

- ASA forged lower receiver
- ASA forged aluminum A2 upper receiver
- Wilson 24" stainless steel 1:8 or 1:9 twist bull barrel
- Precision hard chrome bolt carrier
- Free float aluminum handguard

ASA 24" BULL BARREL A2 RIFLE #R-2400A2 **\$979.95**

ASA RIFLE NO CHARGE OPTIONS

Choice of Stainless Steel Bull barrel length 20", 22" or 24"
(also 16" if Harris Custom Barrel)

1:8 or 1:9 barrel twist rate

Please check for availability prior to ordering

ASA RIFLE UPGRADES

Black Stainless Steel Barrel - Add \$65.00

Fluted Stainless Steel Barrel - Add \$75.00

Ported Barrel - Add \$125.00

Upgrade from Wilson to Custom Harris 16", 20" 22", 24" or 26" Barrel - Add \$50.00

Two Stage Match Trigger - Add \$119.00

National Match Sights- Add \$34.95

MATCH .308 CALIBER RIFLE COMING SOON!

ASA 16" Invader®



MADE IN THE USA

COMPLETE 16" BULL BARREL A2 FEATURING:

- ASA forged lower receiver
- ASA forged aluminum A2 upper receiver
- Custom Harris 16" stainless steel 1:8 or 1:9 twist bull barrel
- Precision hard chrome bolt carrier
- Free float aluminum handguard

ASA 16" INVADER® #R-11600 **\$954.95**

ASA 20" Rifle



MADE IN THE USA

COMPLETE 20" A2 RIFLE FEATURING:

- ASA forged lower receiver
- ASA forged aluminum A2 upper receiver
- Wilson 20" 1:9 twist National Match barrel

ASA 20" A2 RIFLE #R-2000 **\$819.95**

ASA 16" C.A.R. Post-Ban

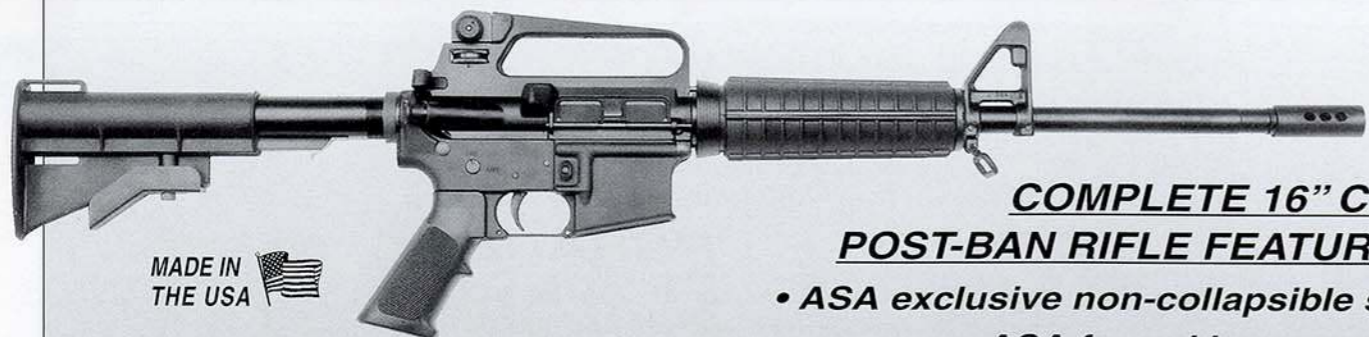

MADE IN THE USA

COMPLETE 16" C.A.R. POST-BAN RIFLE FEATURING:

- ASA exclusive non-collapsible stock
- ASA forged lower receiver
- ASA forged aluminum A2 upper receiver
- Wilson 16" 1:9 twist National Match barrel

ASA 16" C.A.R. RIFLE #R-1600 **\$829.95**

Scopes and Mounts

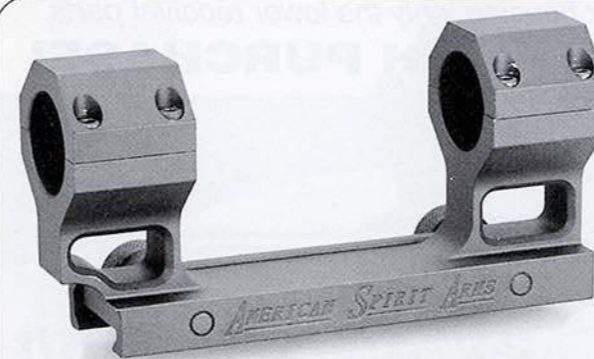

ASA AR SUPER MOUNT

CNC Machined from Billet With Built-In Rings

1 Inch

#P-SM0215 **\$89.95**

30mm

#P-SM0230 **\$99.95**



AR-15/M16 RISER

#P-SM0700 **\$49.95**

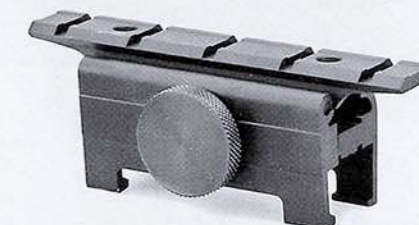

HK91-93/MP5 MOUNT

#P-SM0400 **\$44.95**

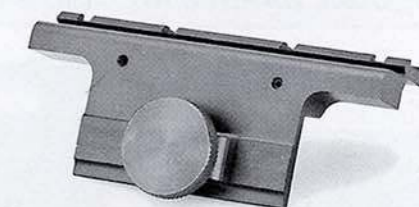

M14 MOUNT

#P-SM0014 **\$44.95**

Kwik Site Rings 1 Inch



#P-S100 **\$14.95**

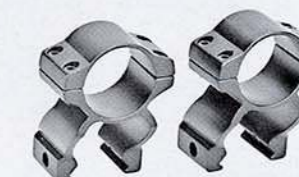

#P-SH100 **\$14.95**



AR-15/M16 MOUNT

#P-SM0015 **\$24.95**

FLASHLIGHT/LASER ACCESSORY SIDE MOUNT

#P-SM0015-A **\$18.95**

Complete AR-15/M16 Mounting System



Tasco World Class 3.5-10x50mm Scope

#P-ST35 **\$274.95**



Tasco World Class 8-32x50mm Scope

#P-ST8 **\$324.95**

AR Magazines

AR Magazines

5 round #P-M0005 **\$11.95**

10 round #P-M0010 **\$11.95**

30 round #P-M0030 **\$14.95**

40 round #P-M0040 **\$19.95**

Mag Cinch

#P-SMH0010 **\$25.00**

Pro-Mag 10 Round Mag

#P-M0050 **\$16.95**

Thermold 30 Round Mag

#P-M0050 **\$32.00**

GI Issue 30 Round Mag

When Available - #P-M0050 **\$35.00**



Complete Weapon Kits

No FFL required - Kits do not include the lower receiver housing, only the lower receiver parts.
ASSEMBLY OF UPPER IS FREE WITH PURCHASE!



24" Bull Barrel Kit

MADE IN THE USA

Everything needed to transform your stripped lower into the ultimate match rifle! Features a stainless steel National Match bull barrel, forged aluminum ASA flattop upper, precision hard chrome bolt carrier, free float aluminum handguard, gas block and gas tube, complete lower parts set and stock. *Scope, base and rings sold separately.*

NO FFL REQUIRED!

- 24" BULL BARREL KIT - Wilson 24" 1:8 or 1:9 twist bull barrel #K-B2004 **\$649.95**
- 24" BULL BARREL KIT - Harris Custom 24" 1:8 or 1:9 twist bull barrel #K-B2005 **\$699.95**



24" A2 Bull Barrel Kit

MADE IN THE USA

Features a stainless steel National Match bull barrel, forged aluminum ASA A2 upper, precision hard chrome bolt carrier, free float aluminum handguard, gas block and gas tube, complete lower parts set and stock.

NO FFL REQUIRED!

- 24" A2 BULL BARREL KIT - Wilson 24" 1:8 or 1:9 twist bull barrel #K-B2003 **\$659.95**
- 24" A2 BULL BARREL KIT - Harris Custom 24" 1:8 or 1:9 twist bull barrel #K-B2002 **\$709.95**



16" Flattop Bull Barrel Kit

MADE IN THE USA

Features a Custom Harris 16" 1:8 or 1:9 twist stainless steel National Match bull barrel, forged aluminum ASA A2 upper, precision hard chrome bolt carrier, free float aluminum handguard, gas block and gas tube, complete lower parts set and stock.

NO FFL REQUIRED!

- 16" FLATTOP BULL BARREL KIT #K-B2001 **\$649.95**



16" A2 Bull Barrel Kit

MADE IN THE USA

Features a Custom Harris 16" 1:8 or 1:9 twist stainless steel National Match bull barrel, forged aluminum ASA A2 upper, precision hard chrome bolt carrier, short free float aluminum handguard, gas block and gas tube, complete lower parts set and stock.

NO FFL REQUIRED!

- 16" A2 BULL BARREL KIT #K-B2000 **\$689.95**

Complete Weapon Kits



ASA 20" A2 Kit

MADE IN THE USA

Transform your stripped lower into a great A2 20". Includes an ASA forged aluminum A2 upper, aluminum trigger guard, aluminum mag catch button and aluminum delta ring. Also available in Flat Top.

NO FFL REQUIRED

- 20" A2 POST-BAN KIT #K-C2000 **\$529.95**
- 20" A2 POST-BAN KIT WITH MUZZLE BRAKE #K-C2002 **\$539.95**
- 20" A2 PRE-BAN KIT #K-C2001 **\$539.95**



ASA C.A.R. 16" Kit

MADE IN THE USA

Transform your stripped lower receiver into a 16" C.A.R. Includes an ASA forged aluminum A2 upper, non-collapsible stock, aluminum trigger guard, aluminum mag catch button and aluminum delta ring. Also available in Flat Top.

NO FFL REQUIRED

- C.A.R. 16" POST-BAN KIT #K-C1600 **\$529.95**
- C.A.R. 16" POST-BAN KIT WITH MUZZLE BRAKE #K-C1602 **\$539.95**
- C.A.R. 16" PRE-BAN KIT #K-C1601 **\$539.95**

It is a violation of federal firearm regulations to configure Pre-ban kits with POST-ban receivers!

ASA Forged Post-Ban Lower Receivers



COMPLETE
 #P-CLR001... **\$214.95**



STRIPPED..... #P-LR001 **\$149.95**

ASA Fully Assembled Post-Ban Lower



A2 POST-BAN
 #P-CLR002
\$274.95



C.A.R. POST-BAN
 WITH NON-COLLAPSIBLE STOCK
 #P-CLR003 **\$269.95**

Complete Upper Halves

MADE IN THE USA 

National Match Bull Barrel Upper Halves

These bull barrel forged uppers are what the match shooters are using at the National Matches! Upper halves include a forged flattop or A2 upper receiver, free float aluminum handguard, gas block and gas tube. Also available with 22" stainless steel bull barrel.



24" & 20" Flattop National Match Upper Half

| | | | |
|--|-----------------|--|-----------------|
| Wilson 1:8 Bull BarrelW-U2408-S | \$379.95 | With Hard Chromed Bolt Carrier & Charging Handle ...W-U2408C | \$539.95 |
| Custom Harris 1:8 Bull BarrelH-U2408-S | \$419.95 | With Hard Chromed Bolt Carrier & Charging Handle ...H-U2408C | \$579.95 |
| Wilson 1:9 Bull BarrelW-U2409-S | \$379.95 | With Hard Chromed Bolt Carrier & Charging Handle ...W-U2409C | \$539.95 |
| Custom Harris 1:9 Bull BarrelH-U2409-S | \$419.95 | With Hard Chromed Bolt Carrier & Charging Handle ...H-U2409C | \$579.95 |

24" Flattop National Match Upper Half

| | | | |
|--|-----------------|--|-----------------|
| Wilson 1:8 Bull BarrelW-U2008-S | \$379.95 | With Hard Chromed Bolt Carrier & Charging Handle ...W-U2018C | \$539.95 |
| Custom Harris 1:8 Bull BarrelH-U2008-S | \$419.95 | With Hard Chromed Bolt Carrier & Charging Handle ...H-U2008C | \$579.95 |
| Wilson 1:9 Bull BarrelW-U2009-S | \$379.95 | With Hard Chromed Bolt Carrier & Charging Handle ...W-U2019C | \$539.95 |
| Custom Harris 1:9 Bull BarrelH-U2009-S | \$419.95 | With Hard Chromed Bolt Carrier & Charging Handle ...H-U2019C | \$579.95 |

20" Flattop National Match Upper Half

| | | | |
|--|-----------------|--|-----------------|
| Wilson 1:8 Bull BarrelW-U2008-S | \$379.95 | With Hard Chromed Bolt Carrier & Charging Handle ...W-U2018C | \$539.95 |
| Custom Harris 1:8 Bull BarrelH-U2008-S | \$419.95 | With Hard Chromed Bolt Carrier & Charging Handle ...H-U2008C | \$579.95 |
| Wilson 1:9 Bull BarrelW-U2009-S | \$379.95 | With Hard Chromed Bolt Carrier & Charging Handle ...W-U2019C | \$539.95 |
| Custom Harris 1:9 Bull BarrelH-U2009-S | \$419.95 | With Hard Chromed Bolt Carrier & Charging Handle ...H-U2019C | \$579.95 |



16" Flattop National Match Upper Half Long Free Float Tube

| | | | |
|--|-----------------|--|-----------------|
| Custom Harris 1:8 Bull BarrelH-U1608-S | \$419.95 | With Hard Chromed Bolt Carrier & Charging Handle ...H-U1608C | \$579.95 |
| Custom Harris 1:9 Bull BarrelH-U1609-S | \$419.95 | With Hard Chromed Bolt Carrier & Charging Handle ...H-U1609C | \$579.95 |



16" Flattop National Match Upper Half Short Free Float Tube

| | | | |
|--|-----------------|--|-----------------|
| Custom Harris 1:8 Bull BarrelH-U1608-S | \$419.95 | With Hard Chromed Bolt Carrier & Charging Handle ...H-U1608C | \$579.95 |
| Custom Harris 1:9 Bull BarrelH-U1609-S | \$419.95 | With Hard Chromed Bolt Carrier & Charging Handle ...H-U1609C | \$579.95 |



24" & 20" A2 National Match Upper Half

| | | | |
|---|-----------------|---|-----------------|
| Wilson 1:8 Bull BarrelW2-U2408-S | \$439.95 | With Hard Chromed Bolt Carrier & Charging Handle ...W2-U2408C | \$589.95 |
| Custom Harris 1:8 Bull BarrelH2-U2408-S | \$469.95 | With Hard Chromed Bolt Carrier & Charging Handle ...H2-U2408C | \$629.95 |
| Wilson 1:9 Bull BarrelW2-U2409-S | \$439.95 | With Hard Chromed Bolt Carrier & Charging Handle ...W2-U2409C | \$589.95 |
| Custom Harris 1:9 Bull BarrelH2-U2409-S | \$469.95 | With Hard Chromed Bolt Carrier & Charging Handle ...H2-U2409C | \$629.95 |

20" A2 National Match Upper Half

| | | | |
|---|-----------------|---|-----------------|
| Wilson 1:8 Bull BarrelW2-U2008-S | \$439.95 | With Hard Chromed Bolt Carrier & Charging Handle ...W2-U2008C | \$589.95 |
| Custom Harris 1:8 Bull BarrelH2-U2008-S | \$469.95 | With Hard Chromed Bolt Carrier & Charging Handle ...H2-U2008C | \$629.95 |
| Wilson 1:9 Bull BarrelW2-U2009-S | \$439.95 | With Hard Chromed Bolt Carrier & Charging Handle ...W2-U2009C | \$589.95 |
| Custom Harris 1:9 Bull BarrelH2-U2009-S | \$469.95 | With Hard Chromed Bolt Carrier & Charging Handle ...H2-U2009C | \$629.95 |



16" A2 National Match Upper Half

| | | | |
|---|-----------------|---|-----------------|
| Custom Harris 1:9 Bull BarrelH2-U1608-S | \$469.95 | With Hard Chromed Bolt Carrier & Charging Handle ...H2-U1608C | \$629.95 |
| Custom Harris 1:9 Bull BarrelH2-U1609-S | \$469.95 | With Hard Chromed Bolt Carrier & Charging Handle ...H2-U1609C | \$629.95 |

Upper Half Bull Barrel Upgrades

All prices shown are for the brushed stainless finish. Add \$65.00 for black, \$75.00 for fluted and \$125.00 for ported.

MADE IN THE USA 

Complete Upper Halves

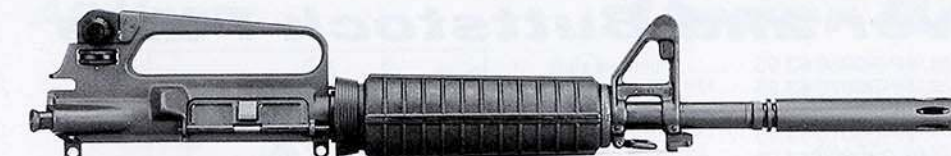

16" Commander Pre-Ban Upper Half

Featuring a forged ASA A2 upper with rear sight, ejection port cover, forward assist and Wilson 11 1/2" National Match Barrel with 5 1/2" flash suppressor.

| | | |
|--|----------|-----------------|
| 16" COMMANDER PRE-BAN UPPER HALF | #A-U162 | \$379.95 |
| 16" COMMANDER PRE-BAN UPPER HALF with Blued Bolt Carrier & Charging Handle | #A-U162C | \$499.95 |



16" C.A.R. Post-Ban Upper Half

Featuring a forged ASA A2 upper with rear sight, ejection port cover, forward assist and Wilson 16" National Match Barrel with permanently attached muzzle brake.

| | | |
|--|----------|-----------------|
| 16" C.A.R. POST-BAN UPPER HALF | #A-U163 | \$349.95 |
| 16" C.A.R. POST-BAN UPPER HALF with Blued Bolt Carrier & Charging Handle | #A-U163C | \$469.95 |



20" Post-Ban Upper Half

Featuring a forged ASA A2 upper with rear sight, ejection port cover, forward assist and Wilson 20" National Match Barrel.

| | | |
|--|----------|-----------------|
| 20" POST-BAN UPPER HALF | #A-U203 | \$349.95 |
| 20" POST-BAN UPPER HALF with Blued Bolt Carrier & Charging Handle | #A-U203C | \$469.95 |
| 20" POST-BAN UPPER HALF with Muzzle Brake | #A-U204 | \$359.95 |
| 20" POST-BAN UPPER HALF with Muzzle Brake and Blued Bolt Carrier & Charging Handle | #A-U204C | \$479.95 |

16" C.A.R. Pre-Ban Upper Half

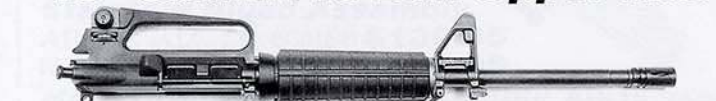

Featuring a forged ASA A2 upper with rear sight, ejection port cover, forward assist and Wilson 16" National Match Barrel.

| | | |
|---|----------|-----------------|
| 16" C.A.R. PRE-BAN UPPER HALF | #A-U160 | \$339.95 |
| 16" C.A.R. PRE-BAN UPPER HALF with Blued Bolt Carrier & Charging Handle | #A-U160C | \$469.95 |

20" Pre-Ban Upper Half



Featuring a forged ASA A2 upper with rear sight, ejection port cover, forward assist and Wilson 20" National Match Barrel.

| | | |
|--|----------|-----------------|
| 20" PRE-BAN UPPER HALF | #A-U202 | \$339.95 |
| 20" PRE-BAN UPPER HALF with Blued Bolt Carrier & Charging Handle | #A-U201C | \$469.95 |

MADE IN THE USA 

Quality Forged Uppers

Charging Handles

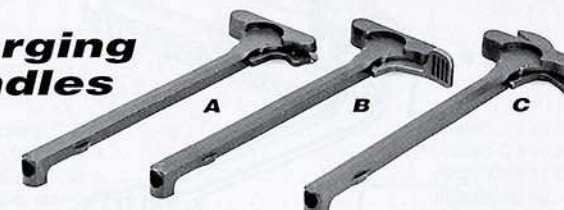

| | | |
|--------------------------------|----------|----------------|
| A - Standard | #P-C0030 | \$21.95 |
| B - Steel Tactical Latch | #P-C0031 | \$38.95 |
| C - Ambidextrous | #P-C0032 | \$38.95 |

Removable Carry Handle

#P-CH1002
\$124.95

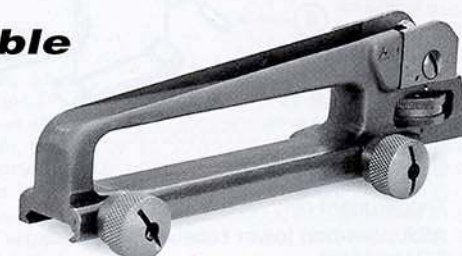

Forged A2 Upper Receiver

With windage and elevation adjustable rear sight and forward assist. No sight tool needed! It has a brass deflector for all you left handers.
Now Only



Forged Flattop Upper Receiver

Now Only



Lower Receiver and Buttstock Parts

1. Recoil buffer spring, standard #P-R0080 \$3.95
1. Recoil buffer spring, CAR #P-R0070 \$3.95
- Buffer, standard #P-B3020 \$12.95
2. Buffer, CAR, aluminum #P-B3010 \$9.95
3. Buffer tube, A2 #P-B3060 \$14.95
3. Buffer tube, C.A.R. #P-B3050 \$12.95
3. Buffer tube, post-ban non-collapsible C.A.R. #P-CR070 \$19.95
5. Safety selector, ambi, AR #P-S0030 \$38.95
5. Selector, AR15 #P-S0015 \$11.95
5. Selector, M16 #P-S0016 \$11.95
6. Bolt catch spring #P-B2035 \$1.00
7. Bolt catch plunger #P-B2025 \$1.00
8. Bolt catch #P-B2020 \$7.95
9. Bolt catch roll pin #P-B2030 \$1.00
10. Magazine catch #P-M0100 \$3.95
11. Takedown detent spring #P-T0040 \$1.00
12. Takedown pin detent #P-T0030 \$1.00
13. Magazine catch spring #P-M0070 \$1.15
14. Magazine catch button, aluminum #P-M0200-A \$1.95
15. Takedown pin, front #P-T0010 \$2.95
16. Disconnecter, #D00015 \$3.95
16. Disconnecter, M16 #D00016 \$3.95
18. Pistol grip screw #P-P0110 \$1.00
19. Pistol grip screw washer #P-P0030 \$1.00
20. Pistol grip, A2 #P-P0020 \$7.95
20. Pistol grip, trapdoor #P-P0040 \$9.95
20. Pistol grip, SPR tactical #P-G0100 \$29.95
20. Pistol grip, target match #P-T0050 \$49.95
21. Safety detent spring #P-S0020 \$1.00
22. Safety detent #P-S0010 \$1.00
23. Hammer pin #P-H0020 \$1.25
25. Takedown pin, rear #P-T0020 \$2.95
26. Buttstock spacer #P-B03005 \$3.00

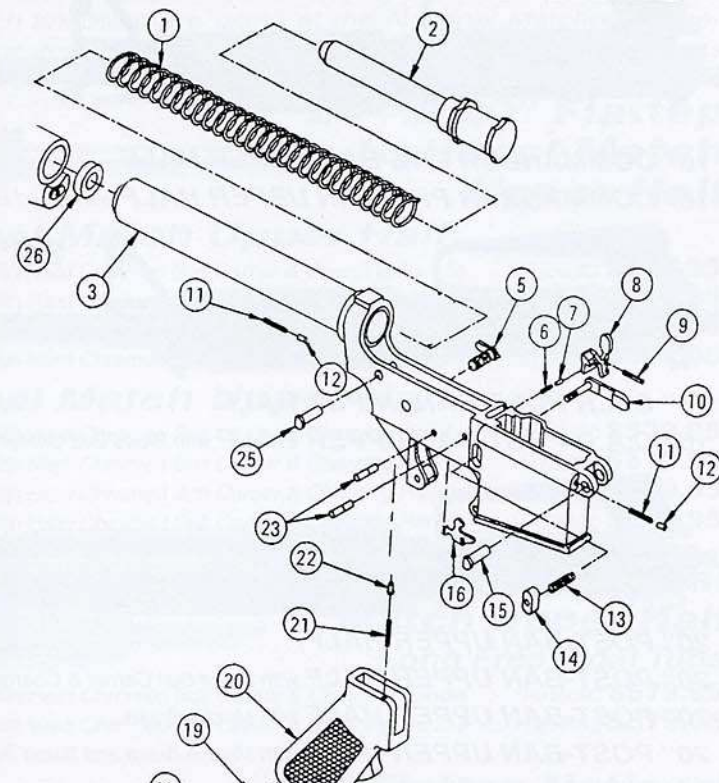

1. Hammer, AR15 #P-H0010 \$14.95
1. Hammer, M16 #P-H0010-16 \$14.95
2. Hammer spring #P-H0030 \$1.20

Custom Trigger and Lightweight Hammer

#P-T0100 \$49.95



Two Stage Trigger and Hammer Set

#P-TRR001 \$119.00

Complete Lower Parts Set

Comes with all the parts shown, including pistol grip.

For AR-15

#A-LP015
\$64.95

*For M-16

Includes auto sear and pin
#A-LP016
\$64.95

*License required for M-16 parts set.

Bonus:

Get the set with the trapdoor pistol grip for an additional \$4.95

Field Repair Kit

AR-15 #K-F001 \$32.95
M-16 #K-F002 \$32.95

A2 Upper

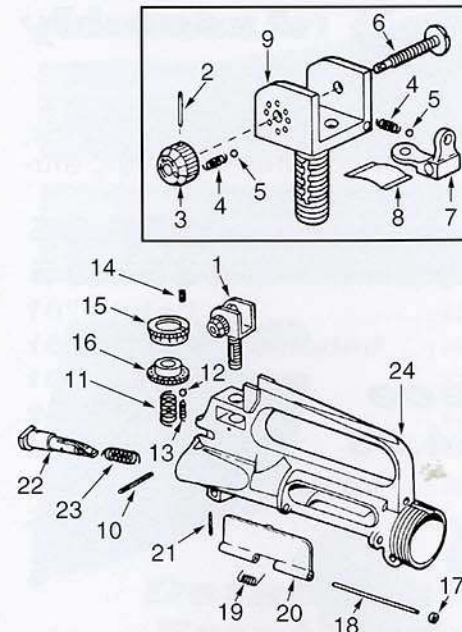

1. Sight assembly #P-R0040 \$37.95
1. Sight assembly, NM #P-R0050 \$44.95
2. Windage knob roll pin #P-W0030 \$1.00
3. Windage knob #P-W0020 \$1.20
3. Windage knob, NM #P-N0020 \$5.95
4. Detent spring, 3 req. #P-S0055 \$1.00
5. Detent ball bearing, 3 req. #P-S0056 \$5.50
6. Windage knob screw #P-W0010 \$2.95
7. Rear sight aperture #P-R0029 \$6.95
7. Rear sight aperture, NM #P-R0010 \$11.95
8. Flat spring #P-R0035 \$1.15
9. Sight base #P-R0041 \$12.95
10. Elevation spring pin, 2 req. #P-R0030 \$1.00
11. Elevation spring #P-R0025 \$1.00
12. Ball Bearing, 3 req. #P-S0056 \$5.50
13. Base spring, 3 req. #P-S0055 \$1.00
14. Index set screw #P-I0010 \$2.95
15. Index nut elevation #P-I0020 \$4.95
16. Index elevation knob #P-I0030 \$3.95
16. Index elevation knob, NM #P-N0010 \$9.95
17. Ejector hinge pin snap ring #P-E0045 \$7.75
18. Ejection port cover rod #P-E0020 \$2.00
19. Ejection port cover spring #P-E0030 \$1.00
20. Ejection port cover, complete #P-E0010 \$7.95
21. Forward assist roll pin #P-F0050 \$1.00
22. Forward assist, round #P-F0060 \$9.95
22. Forward assist, teardrop #P-F0090 \$15.95
23. Forward assist spring #P-F0070 \$1.00
24. Upper, A2, stripped #P-U0200 \$94.95

Bolt Carrier Assembly

Complete with bolt assembly, firing pin, cam pin and gas key

Standard Blued Assembly

AR-15 #A-BC015-B \$139.95

M-16 #A-BC016-B \$139.95

Hard Chrome Plated Assembly AR-15 #A-BC015-C \$189.95

Hard Chrome Plated Assembly M-16 #A-BC016-C \$189.95

Titanium Nitrite Assembly AR-15 #A-BC015-T \$229.95



1. Disconnecter spring #P-D0030 \$1.00
2. Trigger w/spring, AR15 #P-T0060-15 \$14.95
2. Trigger w/spring, M16 #P-T0060-16 \$14.95
3. Trigger spring #P-T0080 \$1.20

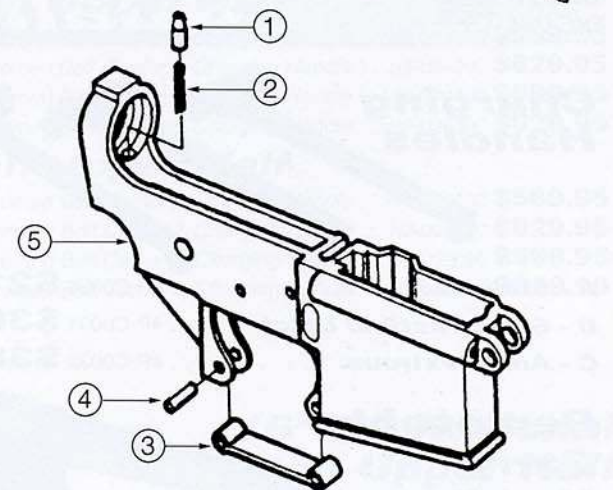

1. Buffer detent #P-B3030 \$1.00
2. Buffer detent spring #P-B3040 \$1.00
3. Triggerguard, aluminum #P-T0090 \$4.95
3. Triggerguard pin #P-T0070 \$1.00
5. ASA post-ban lower receiver stripped, FFL required #P-LR001 \$149.95

Upper Receiver Parts

Bolt Assembly

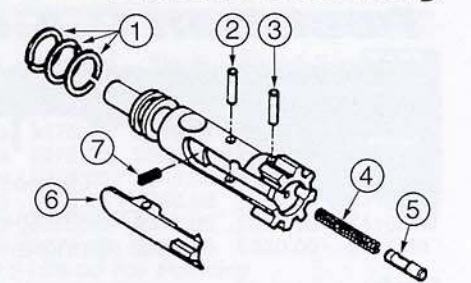

1. Bolt gas ring (1piece) #P-G0010 \$1.95
1. Bolt gas ring set (3 rings) #P-G0015 \$2.95
2. Extractor pin, blue #P-E0080 \$1.20
2. Extractor pin, chrome #P-E0080-C \$2.25
3. Ejector roll pin #P-E0050 \$1.50
4. Ejector spring #P-E0060 \$1.00
5. Ejector, blue #P-E0040 \$4.95
5. Ejector, chrome #P-E0040-C \$7.95
6. Extractor, blue #P-E0070-B \$17.95
6. Extractor, chrome #P-E0070-C \$18.95
7. Extractor spring #P-E0090 \$1.20
- Bolt assembly #P-B2010-B \$59.95
- Bolt assembly, chrome #P-B2010-C \$89.95

Bolt Carrier

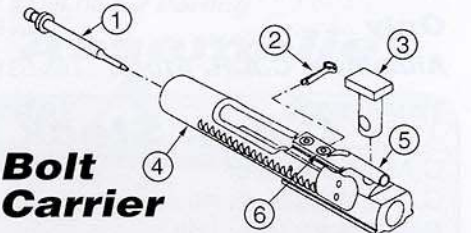

1. Firing pin, AR15 #P-F0015 \$7.95
1. Firing pin, M16 #P-F0016 \$7.95
2. Firing pin retaining pin #P-F0030 \$1.00
3. Cam pin #P-C0010 \$4.95
3. Cam pin, chrome #P-C0010-C \$7.95
4. Bolt carrier #P-B2015-B \$59.95
4. Bolt carrier, chrome #P-B2015-C \$89.95
4. Bolt carrier, M16 #P-B2016-B \$59.95
4. Bolt carrier, M16, chrome #P-B2016-C \$89.95
5. Carrier key #P-C0020-B \$7.95
5. Carrier key, Chrome #P-C0020-C \$10.95
6. Key screw, blue (2 req.) #P-K0010-B \$7.75
6. Key screw, chrome (2 req.) #P-K0010-C \$1.25
6. Key screw, stainless steel #P-K0010-SS \$7.75

Titanium Nitrite Coated Firing Pin

#P-F0015-T \$18.95

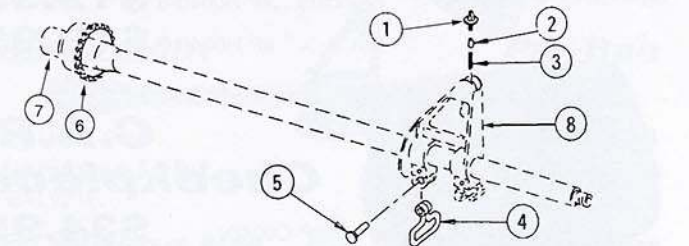

1. Front sight post, A2, square #P-F0120 \$2.95
1. Front sight, including base, detachable #P-F0140 \$89.95
2. Front sight detent #P-F0100 \$1.20
3. Front sight detent spring #P-F0110 \$1.00
4. Front swivel #P-S0130 \$1.90
5. Front swivel pin #P-S0120 \$1.00
6. Barrel nut #P-B0010 \$4.95
7. Barrel extension #P-B0005 \$16.95
8. Front sight base, heavy #P-F0150 \$24.95
8. Front sight base, milled for flattop #P-F0160 \$30.00
8. Front sight base, including sight, detachable #P-F0140 \$89.95
9. Front sight pin (2 required) each #P-F0130 \$1.00
9. Front sight roll pin (2 required) each #P-F0050 \$1.00

1. Handguard, E2 round, long #P-H0040-E \$19.95
1. Handguard, C.A.R. #P-H0040-C \$19.95
2. Gas tube roll pin #P-G0050 \$1.00
3. Gas tube, standard #P-G0040 \$9.95
3. Gas tube, 7" pistol #P-G0020 \$9.95
3. Gas tube, C.A.R. #P-G0030 \$9.95
4. Compensator/flash hider (see page 14)
5. Peel washer #P-P0010 \$1.95
5. Compensator lock washer (A1) #P-L0010 \$1.00
6. Barrel snap ring #P-S0070 \$1.25
7. Weld spring assembly #P-S0075 \$2.95
8. Delta ring, aluminum #P-D0010 \$5.95
9. Barrel, 16", pre-ban, 1:9 #P-BA1600-PR \$144.95
9. Barrel, 16" Commando #P-BA1600-C \$159.95
9. Barrel, 16", post-ban with brake #P-BA1600-PM \$154.95
9. Barrel, 20" post-ban, 1:9 #P-BA2000-P \$144.95
9. Barrel, 20" post-ban with brake, 1:9 #P-BA2000-PM \$154.95
9. Barrel, 20" pre-ban #P-BA2000-PR \$144.95
10. Handguard cap, round, heavy #P-H0140 \$1.95
10. Handguard cap, triangle, heavy #P-H0150 \$1.95
10. Handguard cap, C.A.R., heavy #P-H0160 \$39.95

Upgrades and Options

AMERICAN SPIRIT EXCLUSIVE Non-Collapsible Post-Ban C.A.R. Stock



Comes with all new parts, including buttstock, buffer tube, recoil spring and aluminum buffer.

Only #A-BS162 **\$69.95**

Collapsible C.A.R. Stock



New Improved Version!

This 4-position, collapsible stock is made of durable high impact plastic with aluminum buffer and recoil spring.

Only #A-BS160 **\$59.95**

Aluminum C.A.R. Stock... #A-BS161 **\$109.95**

C.A.R. Stock Parts

| | | |
|------------------------------|---------|--------|
| C.A.R. stock lever..... | P-CR010 | \$3.90 |
| C.A.R. stock lever nut..... | P-CR015 | \$.85 |
| C.A.R. stock lever bolt..... | P-CR030 | \$1.50 |
| C.A.R. stock lock ring..... | P-CR040 | \$2.95 |
| C.A.R. stock lock plate..... | P-CR050 | \$2.50 |
| C.A.R. fixed stock bolt..... | P-CR060 | \$1.00 |



Standard or C.A.R. 2 Piece Handguard

Standard... #P-H0040-E **\$19.95**

C.A.R.... #P-H0040-C **\$19.95**



C.A.R. Cheekpiece

#P-C0040..... **\$34.95**

C.A.R. Rubber Buttpad

No slip, natural rubber

#P-R0060 **\$9.95**

2 inch buttpad..... #P-R0075 **\$14.95**

ASA Buttstock Assembly



Comes with all new parts, including buttstock, buffer tube, recoil spring, stock spacer, aluminum buffer and buttstock screws.

Complete Assembly #A-BS002 **\$59.95**

A2 Buttstock Only #P-S0090 **\$38.95**

A2 Cheekpiece

#P-LP001..... **\$44.95**



Standard A2 #P-P0020 **\$7.95**

With Trapdoor #P-P0040 **\$9.95**

Pistol Grips

Standard
#P-G0100 **\$24.95**

Target Match Adjustable
#P-T0050 **\$49.95**



Ergo Pistol Grips

Standard #P-G00ES **\$24.95**

Ambidextrous... #P-G00EA **\$24.95**

Competition Pistol Grip

Competition, with Palm Rest
#P-G00CP **\$69.95**

Standard, with Palm Rest
#P-G00TP **\$59.95**



Upgrades and Options

Free Float Anodized Aluminum Handguards



16" Fluted #P-F1600F **\$39.95**

16" Standard Knurled #P-F1600S **\$39.95**

16" Vented #P-F1600V **\$39.95**

20" Fluted #P-F2000F **\$39.95**

20" Knurled #P-F2000K **\$39.95**

20" Standard Knurled #P-F2000S **\$39.95**

20" Vented #P-F2000V **\$39.95**

Detachable Front Sight and Sight Base

#P-F0140..... **\$89.95**



New Bull Barrel Gas Block

#P-G0060..... **\$39.95**

Standard Gas Block #P-G0070 **\$19.95**

Aluminum Gas Block #P-G0070-A **\$29.95**

Steel Gas Block #P-G0070-S **\$29.95**

Muzzle Brakes and Flashhiders



1. **A2 Birdcage 5 Slot Flashhider**
#P-B1020..... **\$7.95**

2. **Predator Flashhider**
#P-B1025..... **\$24.95**

3. **Post-ban Aluminum Muzzle Brake**
#P-M0610-PA..... **\$19.95**

4. **AK74 Style Muzzle Brake**
#P-B1026..... **\$24.95**

5. **Combat Muzzle Brake**
#P-M0610-C..... **\$19.95**

6. **Extended Post-ban Steel Muzzle Brake**
#P-M0610-PS..... **\$24.95**

7. **Extended Post-ban Aluminum Muzzle Brake**
#P-M0611-PA..... **\$24.95**

8. **C.A.R. 5 1/2" Flashhider**
#P-F0040..... **\$19.95**

Harris Custom National Match Stainless Steel Bull Barrels

| Length | Twist | Part# | Standard | Black | Fluted | Black Fluted |
|--------|-------|--------|----------|----------|----------|--------------|
| 16" | 1:8 | BH1618 | \$275.00 | \$340.00 | \$350.00 | \$415.00 |
| 16" | 1:9 | BH1619 | \$275.00 | \$340.00 | \$350.00 | \$415.00 |
| 20" | 1:8 | BH2018 | \$275.00 | \$340.00 | \$350.00 | \$415.00 |
| 20" | 1:9 | BH2019 | \$275.00 | \$340.00 | \$350.00 | \$415.00 |
| 22" | 1:8 | BH2218 | \$275.00 | \$340.00 | \$350.00 | \$415.00 |
| 22" | 1:9 | BH2219 | \$275.00 | \$340.00 | \$350.00 | \$415.00 |
| 24" | 1:8 | BH2418 | \$275.00 | \$340.00 | \$350.00 | \$415.00 |
| 24" | 1:9 | BH2419 | \$275.00 | \$340.00 | \$350.00 | \$415.00 |

Add \$125.00 for Porting

Wilson National Match Stainless Steel Bull Barrels

| Length | Twist | Part# | Standard | Black | Fluted | Black Fluted |
|--------|-------|--------|----------|----------|----------|--------------|
| 20" | 1:8 | BH2018 | \$225.00 | \$290.00 | \$300.00 | \$365.00 |
| 20" | 1:9 | BH2019 | \$225.00 | \$290.00 | \$300.00 | \$365.00 |
| 22" | 1:8 | BH2218 | \$225.00 | \$290.00 | \$300.00 | \$365.00 |
| 22" | 1:9 | BH2219 | \$225.00 | \$290.00 | \$300.00 | \$365.00 |
| 24" | 1:8 | BH2418 | \$225.00 | \$290.00 | \$300.00 | \$365.00 |
| 24" | 1:9 | BH2419 | \$225.00 | \$290.00 | \$300.00 | \$365.00 |

Add \$125.00 for Porting

Barrel Assemblies

16" Commander **Pre-Ban**

Wilson 11 1/2" NM barrel with 5 1/2" Flash Suppressor
#P-BA1600-C..... **\$159.95**

16" NM Heavy **Pre-Ban**

16" Wilson NM 1:9 twist barrel with A2 5 Slot Flash Suppressor
#P-BA1600-PR..... **\$144.95**

M-4 **Pre-Ban**

#P-BA1600M4-PR..... **\$174.95**

M-4 **Post-Ban**

#P-BA1600M4..... **\$179.95**

Lightweight **Pre-Ban**

#P-BALW01-PR..... **\$174.95**

Lightweight **Post-Ban**

#P-BALW01..... **\$179.95**

16" Wilson NM **Post-Ban**

#P-BA1600-P..... **\$144.95**
With permanent Muzzle Brake..... #P-BA1600-PM **\$154.95**

20" Wilson NM **Post-Ban**

#P-BA2000-P..... **\$144.95**
With permanent Muzzle Brake..... #P-BA2000-PM **\$154.95**

Upgrades and Options

Pistol Recoil Buffer

Made from solid steel with more weight in back for better balance.



Special #P-P1000 **\$49.95**
Pistol Buffer Spring #P-P0090 **\$3.95**

Two Stage Trigger and Hammer Set



#P-TRR001 **\$119.00**

Steel Tactical Latch

#P-CH001T **\$16.95**



Ambidextrous Latch

#P-CH002A **\$16.95**



Tactical Flipup Rear Sight

#P-SRF001 **\$97.95**

Harris Bipods



L Series

S #R-B0320 **\$94.95**
L #R-B0300 **\$64.95**
LM #R-B0310 **\$64.95**

Harris Bipod Adapter
 #R-B0200 **\$9.95**

Black Nylon Sling

P-S0060 **\$3.95**

Extended Nylon Sling

P-S006 **\$9.95**

We have Tactical Slings available please call for more information



Brass Catcher

A2 with scope
 #P-B2105 **\$18.95**
A2 without scope
 #P-B2100 **\$12.95**
Flattop
 #P-B2101 **\$29.95**

Tools and Manuals

New Heavy Duty Armorer's Barrel Wrench



4 tools in one! A non-slip barrel nut wrench big enough to handle the large bull barrels, a flash suppressor slot, and a standard extension tube slot.

#P-B0050 **\$39.95**

Flat Barrel Wrench



#P-B0030 **\$10.95**

Field Headspace Gauge
 P-H0050 **\$24.95**

AR Front Sight Adjustment Tools



#S-0050-A2 **\$6.95**

#S-0050-A1 **\$6.95**



Armorer's Action Block Kit

#P-A0050 **\$39.95**

Lower Receiver Block
 P-A0051 **\$19.95**

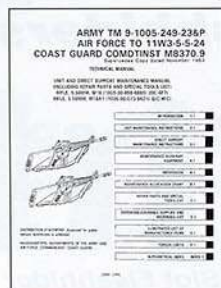

US Army Technical Manual

Maintenance Rifle, 5.56mm M16 and M16A1 **\$19.95**



USMC Technical Manual

Rifle, 5.56mm M16A2 W/E #9-M0500 **\$7.95**



American Spirit Arms began its relentless pursuit to develop the ultimate in AR15 style rifles and accessories in 1998. Today the American Spirit Arms, team takes pride in offering its complete product line for firearms owners, from the novice to the competitive professional. American Spirit Arms is committed to a policy of continuous improvement and new product design. American Spirit Arms currently sponsors 3 Grand Master Shooters and 1 Master Shooter, as well as several national and international shooting competition events. We welcome your calls and invite you to visit our facility and our internet site anytime.



American Spirit Arms, Corp.
 15001 N. Hayden Rd. Suite 112
 Scottsdale, Arizona 85260
 Tel: 888-486-5487 Fax: 480-483-5301
 www.gunkits.com



ALL MILITARY AND LAW ENFORCEMENT SALES ARE CONDUCTED THROUGH THE ARMORY



THE ARMORY

Military and Law Enforcement Sales

15001 N. Hayden Rd. Suite 110A
 Scottsdale, Arizona 85260
 480-348-1111 www.azarmory.com

- ◆ Custom Tactical Rifles
- ◆ Full Auto Rifles (9mm, .223 and .308)
- ◆ Tactical Web Gear
- ◆ Specialty Ammunition
- ◆ Suppressed Weapons Systems
- ◆ Unit Training & Weapons Packages





2000 Catalog

American Spirit Arms, Corp.

6275



ORDER TOLL FREE: 1-888-GUN-KITS - 1-888-486-5487

To place a mail-in order please call our toll free number for shipping charges. Visa and MasterCard accepted, or send your order along with a money order for the full amount. An ink signed FFL is required for all shipments of rifles and lower receivers. We abide by all state and local laws. Prices subject to change without notice. Shipping always ASAP via UPS. COD's accepted. Money Orders preferred. All non-defective returns subject to 20% restocking fee.

VISIT OUR ONLINE CATALOG AT WWW.GUNKITS.COM

AMERICAN SPIRIT ARMS CORP.

15001 North Hayden Road, Suite 112
Scottsdale, Arizona 85260



*American Spirit Arms, Corp.
is proud to introduce the AS308!!*

- Features:
- CNC Machined Upper and Lower from Billet.
 - Stainless Harris Match Barrel
 - Exclusive Side Charging Handle
 - Custom Tuned 2 Stage Trigger

Retail: \$1800.00 Dealer: \$1450.00
Quantity 5+ : \$1375.00

ASA 9mm Conversion Kit & Rifle Set Up

Now Available !!

*Magazine Conversion made as one piece!
It cannot fall out!!*



Magazine Conversion
Retail: \$149.95 Dealer: \$109.95

9mm Kit
Retail: \$699.95 Dealer: \$599.95

Rifle Built with Kit
Retail: \$949.95 Dealer: \$849.95

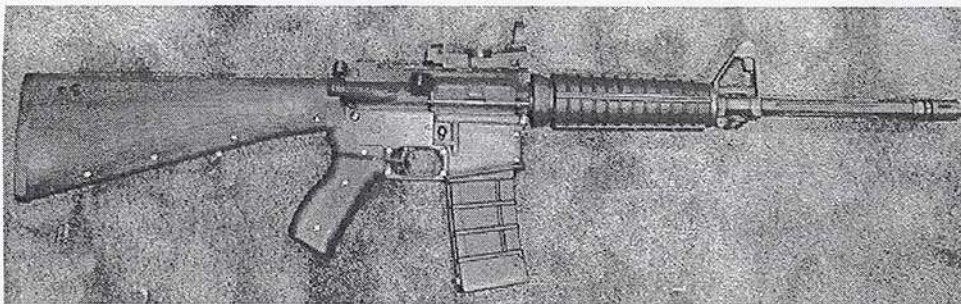
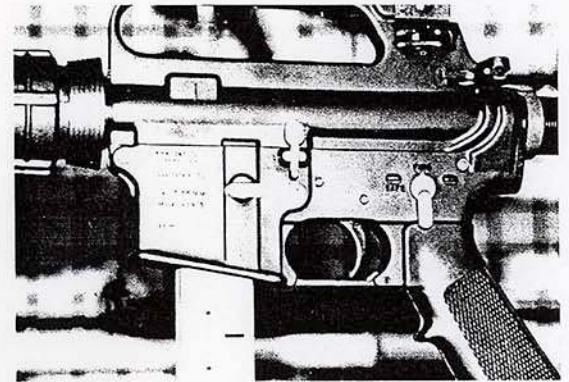

ASA 16'' PR-15

- Space Age Polymer Design
- Substantially lighter than traditional rifles
- Superior Corrosion Resistance
- Available in Field Green or Black
- Suggested retail price: \$700.00

DEALER PRICE: \$550.00!! (3 rifle initial order)